

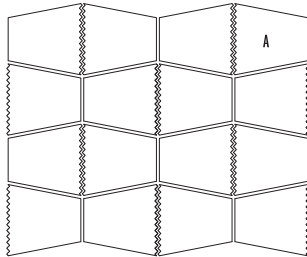

VALENCIA

DESCRIPTION: Fire pit **TEXTURE:** Split Face and Aged

PALLET OVERVIEW



T TECO-BLOC WARRANTY APPLIES TO BRANDON STONES
THE WARRANTY **DOES NOT APPLY** TO ACCESSORY KIT

NOTES

A Spark screen should always cover the fire bowl when the fireplace is in use.

Insert sold separately. Techo-Bloc is not responsible for any damages to the firepit if it is not installed with a sleeve or accessory kit.

See 282 for more technical information.

Specifications per pallet	Imperial	Metric
Cubing	80 units	80 units
Approx. Weight	1 557 lbs	706 kg
Height	14 $\frac{3}{4}$ in	375 mm
Exterior Diameter	48 $\frac{15}{16}$ in	1 243 mm
Interior Diameter	29 $\frac{1}{8}$ in	740 mm
Number of rows	5	

Unit dimensions	in		mm		Units/pallet
	in	mm	in	mm	
Height	2 $\frac{15}{16}$	75	29 $\frac{1}{8}$	740	80 units
Depth	9 $\frac{13}{16}$	250	48 $\frac{15}{16}$	1 243	
Length	9 $\frac{3}{4}$	247	29 $\frac{1}{8}$	740	

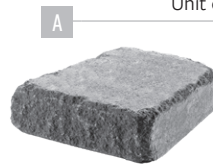

Insert

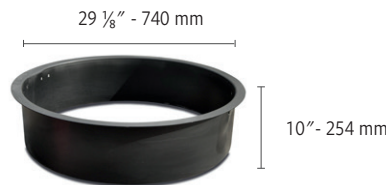

Chestnut Brown



Mojave Beige



Sandlewood



Champlain Grey

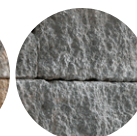

Shale Grey

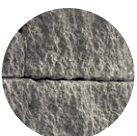

INSTALLATION GUIDE

VALENCIA FIRE PIT

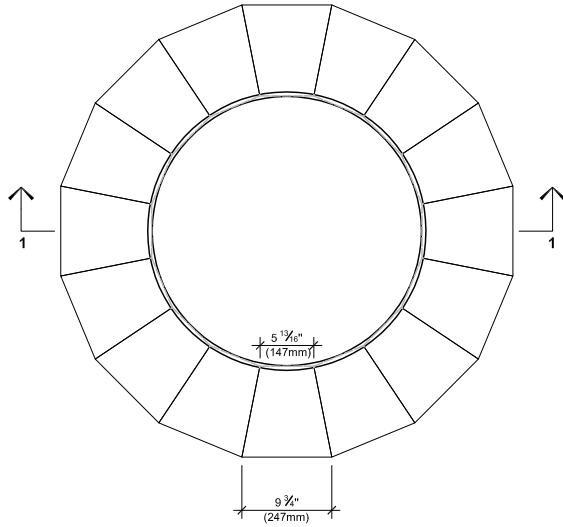

TOP VIEW

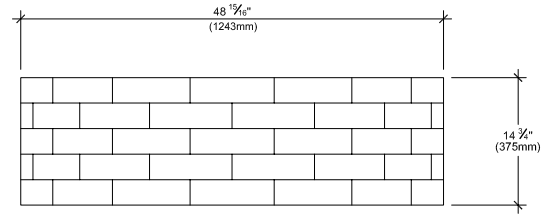

ELEVATION A

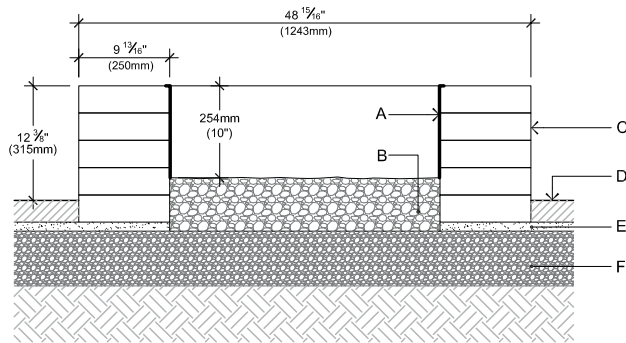

SECTION 1-1

- A. STEEL BOX INSERT
- B. CLEAN STONE 3/4" (20 mm), 6" (150 mm) THICK
- C. VALENCIA BLOCK
- D. TECO-BLOC PAVERS OR SLABS
- E. SETTING BED 1" (25 mm)
- F. COMPACTED GRANULAR BASE 0-3/4" (0-20 mm)

QUANTITY OF MATERIALS REQUIRED

- Valencia block: **80**

NOTE: Secure the blocks using a heat resistant concrete adhesive. The installer must ensure that the installation and use of the fire pit comply with local regulations and code requirements.

Consult our Installation Guide in our website for a detail step by step installation.

PLEASE REFER TO P.4 FOR THE CORRECT USE AND LIMITATIONS OF PROVIDED TECHNICAL INFORMATION.