

VESTAL

Celebrating



1946

2021



**PROUDLY PRODUCING AMERICAN-MADE
PRODUCTS SINCE 1946**

Vestal Manufacturing Enterprises, Inc.

P.O. Box 420 • Sweetwater, Tennessee 37874

Sales 1-800-456-9562 • Local 423-337-6125

Fax 423-337-2003

vestal@vestalmfg.com • www.vestalmfg.com





Be Green!



Environmentally Focused

- 100% of the iron used to make Vestal castings is **scrap metal**.
- Thousands of tons of **scrap metal**, that otherwise may be scattered across the country or dumped in landfills, are recycled annually.
- Approximately 96% of our green sand is **reclaimed** daily and reused in our molding process.
- Closed loop water system provides **reduced water** consumption by 20 million gallons of water annually.
- Energy **efficient lighting** in all Vestal office and manufacturing facilities.
- All excess cardboard is accumulated and sent to a recycling center.



TERMS AND GENERAL INFORMATION

TERMS:

Terms will be specified on each individual invoice. A service charge of 1 1/2% per month (18% ANNUAL RATE) will be assessed for all past due accounts. Where applicable, the service charge will be adjusted to meet state legal requirements.

PALLETIZING MATERIAL:

Certain Vestal products must be palletized for shipping at a net charge per pallet. There is also a net charge for heavy wooden shipping boxes. The boxes and pallets are not returnable.

DAMAGES, SHORTAGES OR LOSS IN TRANSIT:

Merchandise is inspected and counted before loading. Please inspect carefully on receipt of merchandise, noting any discrepancy or damage on the carrier's freight bill AT TIME OF DELIVERY.

Discrepancies or damage which obviously occurred in transit are the carrier's responsibility, and related claims should be made promptly, direct to the carrier. DEDUCTIONS FROM INVOICES FOR SHORTAGES OR DAMAGE CLAIMS WILL NOT BE ALLOWED.

Our responsibility as shipper ceases when goods are delivered in good order to the transportation company. We assume no liability for merchandise in transit. We will, however, render all possible assistance in recovering lost goods or in filing claims by consignee.

PRICES:

Subject to change without notice. All merchandise will be invoiced at prices in effect at time of shipment.

HANDLING CHARGE:

UPS shipments are assessed a \$4.00 charge per shipment. Quantities will be rounded up to the next even bundle unless specifically requested, then special charge will apply. A special \$5.00 handling charge will also be assessed on any product when quantity ordered is less than standard package.

RETURN GOODS:

Return goods will not be accepted without written authority from Vestal Manufacturing. A minimum charge of 20% will be made for handling, inspecting and repackaging items returned for credit. All returned goods must be shipped transportation charges prepaid. DEDUCTIONS FROM INVOICES FOR DAMAGES, DEFECTIVE, AND SHORTAGE CLAIMS WILL NOT BE ALLOWED.

TAXES:

Prices do not include sales, excise, transportation and other similar taxes present or future.

DELIVERY:

Shipments and deliveries are, at all times, subject to approval of our Credit Department. Delivery is contingent on floods, strikes, acts of God, or any other causes beyond or control.

PART CODE:

When placing orders, please give part code first, then model number.

PLANT CLOSINGS:

Vestal Manufacturing always closes the weeks of July 4th and December 25th. No shipping, receiving, or production will occur during these times.

Building Products

Anchor Bolts	BP-21
Ash Caddy	BP-13
Ash Dumps	BP-13
Basement Columns	BP-22, BP-23, BP-24
Bell Traps.....	BP-31
Bell Trap (Lid Only)	BP-31
Brick Clamp	BP-19
Brick Vents.....	BP-18
Cesspool Plates.....	BP-31
Chimney Caps	BP-9
Chimney Top Dampers	BP-9
Circulator Duct System.....	BP-5
Circulator Fans	BP-6
Circulator Fireplaces.....	BP-4
Circulator Grilles.....	BP-5
Cleanout Doors.....	BP-14
Crawlspace Doors	BP-18
Crawlspace Doors (Insulated)	BP-18
Dampers.....	BP-11, BP-12
Damper Controls	BP-10
Damper Valve Plates	BP-10
Dutch Oven Doors.....	BP-14
Fire Bricks.....	BP-8
Fire Clay & Heat Stop.....	BP-8
Fire Pits (Round)	BP-2
Fire Pits (Square)	BP-3
Flue Liners.....	BP-8
Foundation Anchors.....	BP-21
Foundation Black Plastic Flood Vent	BP-17
Foundation Vents	BP-15, BP-16, BP-17, BP-18
Frames and Covers	BP-30
Galvanized Brick Lintel	BP-25
Lag Bolts.....	BP-1
Lintels	BP-25, BP-26
Metal Lath.....	BP-19
Mortar Boxes and Tubs	BP-20
Multi-Opening Damper Corner Supports.....	BP-12
Outdoor Barbecue Grates	BP-30
Outside Air Kits.....	BP-7
Rake Angle	BP-26
Rebar Chairs	BP-21
Sealed Energy Damper	BP-12
Steel Angle	BP-27, BP-28, BP-29
Tile Strainers	BP-31
Trench Drains	BP-31
Wall Ties.....	BP-20
Wall Tie Nails.....	BP-1
Window Wells.....	BP-19



Originally designed and crafted by Americans, Vestal products are the most widely accepted in the industry. Over 75 years of producing goods of proven performance, quality, and durability for home and industry have made Vestal Manufacturing the leader in its field.

Our complete and diversified line of metal building products is accepted by architects, builders, and homeowners. Fireplace accessories add taste and distinction to any hearth. Our modern foundry produces all our cast iron products as well as municipal and O.E.M. castings. We currently produce specialty castings for some of the largest and most recognized companies in America. More information on our foundry capabilities is available upon request, and we invite your inquiries. Vestal products are also sold internationally by the finest dealers and distributors.

We are grateful to all customers who have made the growth of our company and the widespread acceptance of our products possible.

**OUR MOST VALUED ASSET
.....A SATISFIED CUSTOMER!**

**VESTAL MANUFACTURING
Sweetwater, TN 37874
800-456-9562**



When Selling Vestal Products Don't Miss The Extra Sale!



Part Code: 88-031

Model# LAG-3

- 10 Lag Bolts and Washers per box
- Every punched angle iron sale should include Vestal's New convenient and economically packaged Lag Bolts and Washers
- 50 boxes per Master Carton
- 36 Master Cartons Per Pallet
- Master Carton weight 43 lbs.
- Imported



Part Code: 86-012

Model# GWT-2.5

- 500 Galvanized Wall Ties Nails per box
- Every Wall Tie sale should include Vestal's New convenient and economically packaged Galvanized 2 1/2" Wall Tie Nails
- 8 Boxes per Master Carton
- 36 Master Cartons per Pallet
- Master Carton weight 40 lbs.
- Imported



Outdoor Fire Pits



Round

Model No. R-FPFG
Part Code: 28-006

- * 32" I.D. Round Fire Pit
- * Includes removable flip grill with cool-to-the touch spring handles
- * 11 gauge solid steel
- * High heat paint finish
- * 6 1/2" height with 1 1/2" lip
- * Product weight: 60 lbs.



Model No. R-FP
Part Code: 28-007

- * 32" I.D. Round Fire Pit
- * 11 gauge solid steel
- * High heat paint finish
- * 6 1/2" height with 1 1/2" lip
- * Product weight: 41 lbs.



Model No. R-LG
Part Code: 28-008

- * 32" O.D. Log Grate to fit into into R-FPFG & R-FP
- * 1/2" solid steel bar
- * High heat paint finish
- * 6" height
- * Product weight: 17 lbs.

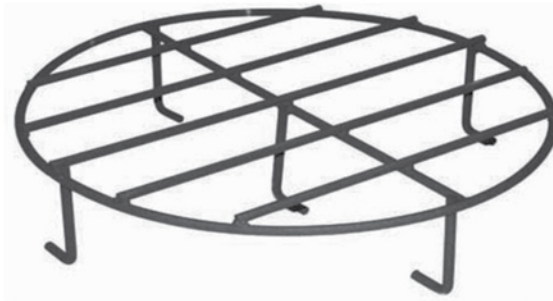



Outdoor Fire Pits



Square

Model No. S-FPFG
Part Code: 28-009

- * 28" Square Fire Pit
- * Includes removable flip grill with cool-to-the touch spring handles
- * 11 gauge solid steel
- * High heat paint finish
- * 6 1/2" height with 1 1/2" lip
- * Product weight: 65 lbs.



Model No. S-FP
Part Code: 28-010

- * 28" Square Fire Pit
- * 11 gauge solid steel
- * High heat paint finish
- * 6 1/2" height with 1 1/2" lip
- * Product weight: 38 lbs.



Model No. S-LG
Part Code: 28-011

- * 28" Square Log Grate to fit into S-FPFG & S-FP
- * 1/2" solid steel bar
- * High heat paint finish
- * 6" height
- * Product weight: 17 lbs.



Proven Performance for Over 75 Years

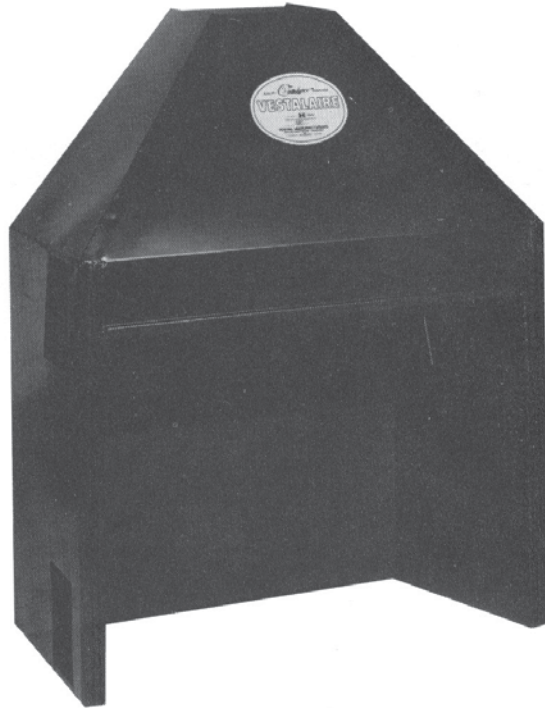

VESTALAIRE

Test Standard: UL 127
 Test Date: October 1992
 Test Report: #632-214200

VESTALAIRE CIRCULATOR FIREPLACE*

RECTANGULAR SHAPE WITH POKER CONTROL FOR EASY MASONRY INSTALLATION

Model No.	Fireplace Opening		Overall Dimensions			Standard Pkg.	Wt. Ea. lbs.	Part Code
	Width	Height	Width	Depth	Height			
30	30"	25"	34"	18½"	46¼"	1	182	50-001
34	34"	27"	38"	19¾"	49¾"	1	217	50-002

***Vestal Chimney Cap Recommended To Protect Fireplace**

***4 UNITS PER PALLET**

VESTAL MANUFACTURING
 Sweetwater, TN 37874
 800-456-9562

DS-9 GRILLE AND DUCT SYSTEM

THE VESTAL DS-9 GRILLE AND DUCT SYSTEM will save time and money when the mason is installing one of Vestal's circulating fireplaces. It increases heating efficiency by providing smooth unobstructed air flow passages and eliminates loss of heated air due to loose fitting joints. We recommend the use of the Vestal F-9 Fan Kit for greater efficiency with the DS-9 Grille and Duct System.

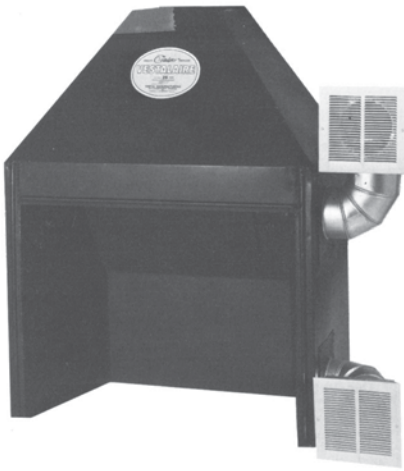

Model No.	Description	Complete Assembly	
		Wt. lbs.	Part Code
DS-9	Complete assembly including 4 each Model 9 Grille and Housing, for side or front installation.	17	50-022

NOTE: If fans are desired for DS-9 Grille and Duct System, order above DS-9 assembly plus 2 F-9 motors.

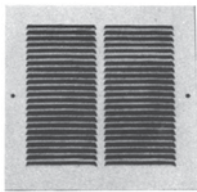

VESTALAIRE GRILLE AND HOUSING

FOR ALL VESTALAIRE AND TUBE-AIRE CIRCULATORS

Model No.	Description	Grille Size	Housing Size	Standard Pkg.		Part Code
				Qty.	Wt. lbs	
9	Stamped Steel*	9 ³ / ₈ " x 9 ³ / ₈ "	7 ⁷ / ₈ " X 7 ⁷ / ₈ "	4	7	50-007
9 Grill w/ Flame	Stamped Steel*	9 ³ / ₈ " x 9 ³ / ₈ "	7 ⁷ / ₈ " X 7 ⁷ / ₈ "	4	7	50-083

*Use with Model F-9 Fan only.



Vestal recommends the following when purchasing a Vestal aire.

What you need for each Vestal aire for proper Installation.

OPTION 1: Any size Vestal aire, 2 pieces F-9 Fans (50-008) and 4 pieces #9 Grill (50-007).

OPTION 2: Any size Vestal aire, 2 pieces F-9 Fans (50-008) and 4 pieces #9 Grille With Flame (50-083).

OPTION 3: Any size Vestal aire, 2 pieces F-10 (50-085) and 2 pieces #9 Grill (50-007)

OPTION 4: Any size Vestal aire, 2 pieces F-10 With Flame (50-084) and 2 pieces #9 Grill With Flame (50-083).

All units should be installed with Vestal outside air kit Model OA (50-011)

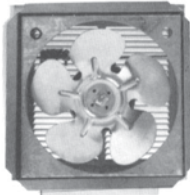

5 watt .5 amp
 115V 60/50 HZ
 1450 RPM/CW - Class B
 140 CFM ea.
 Impedance protected.



CIRCULATOR FAN WITH ENCLOSED MOTOR
 COMPLETELY ASSEMBLED

The Model F-10 fan is completely assembled consisting of an enclosed motor, complete with grille and housing. Individual housing box provides easy slip-in installation. Color coded wiring. Component parts of the F-10 are UL listed.

Model No.	Description	Standard Package		Part Code
		Quantity	Wt. lbs	
F-10	Circulator fan with enclosed motor complete with grille and housing. 5 point aluminum blade with 7" span 9 ³ / ₈ " x 9 ³ / ₈ " Grille Size	2	11	50-085
F-10 Flame	Circulator fan with enclosed motor complete with flame grille and housing. 5 point aluminum blade with 7" span, 9 ³ / ₈ " x 9 ³ / ₈ " Grille Size	2	11	50-084

*Priced per each fan.

VESTALAIRE ELECTIRC FAN
 TO BE USED ONLY ON THE BOTTOM AIR INTAKES

Model No.	Description	Fits	Standard Package		Part Code
			Quantity	Wt. lbs.	
F-9	Motor, Fan & mounting Bracket, 100 CFM	9 Grilles 5" Blade Span	2	4	50-008

"OA" VESTAL OUTSIDE AIR KIT
 FOR NEW CONSTRUCTION -MASONRY FIREPLACES

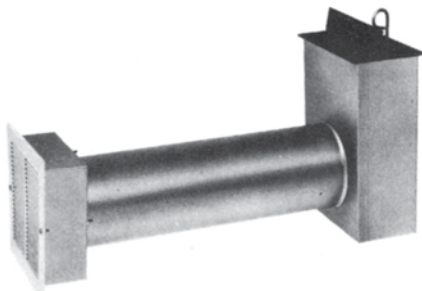

* 30 per pallet

THE VESTAL OUTSIDE AIR KIT is designed to provide outside air for fireplace combustion. It may also be used as a conventional ash dump when a Vestal cleanout door is installed during construction. The unit is furnished with a Vestal cast iron ash dump, outside air grille with screen and adjustable outside air damper. The telescoping 6" air supply adjusts from 21" minimum to 38" maximum. Additional tube may be added if desired

Model No.	Description	Standard Package	Wt. lbs.	Part Code
OA	Outside Air Kit	1	16	50-011

VESTAL MANUFACTURING
 Sweetwater, TN 37874
 800-456-9562



Outside Air Kits

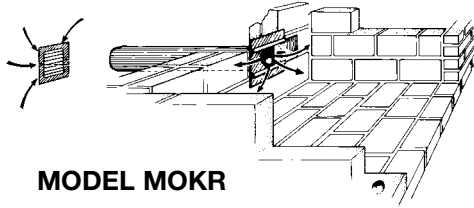

MODEL MOKR

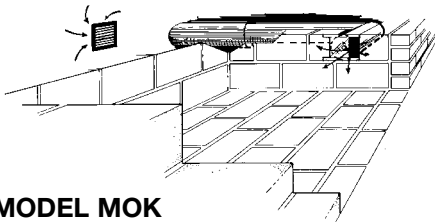

MODEL MOK

FIREPLACE VENTILATOR -- OUTSIDE AIR 3" x 16 Ga. Tubing - Sliding damper to control air flow Easy to install Outside Grille - Aluminum (No Rusting)

Model No.	Description	Standard Package		Part Code
		Quantity	Wt. Lbs.	
MOKR	Installs either during construction or after in the rear of fireplace. Adjustable tubing 9"-10"	1	5	50-047
MOK	Installs during construction in either side of fireplace. Adjustable tubing 19"- 33"	1	11	50-048

*50 per pallet



V-601K SPIN-AIRE OUTSIDE AIR KIT

"Seals Air Tight"

Warehoused & Distributed By:
VESTAL MANUFACTURING
177 INDUSTRIAL PARK ROAD
SWEETWATER, TENNESSEE 37874

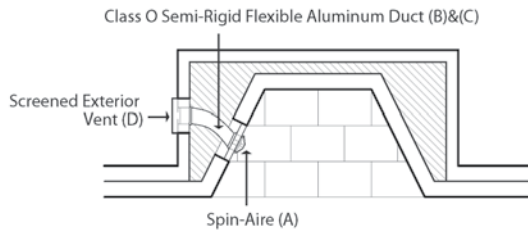

GASKET DESIGNED TO SEAL the combustion air intake opening in a firebox **TIGHT** from outside air.

PROVIDES a 7² inch **PASSAGEWAY**, from the outside fresh air environment to the firebox.

MAXIMIZES ENERGY EFFICIENCY by using outside unconditioned air versus conditioned interior air for combustion.

FIRE SAFE! Burning material can't fall into combustible spaces because the intake opening is designed to be located above the hearth and as a fail-safe, the kit parts are non-combustible and surrounded by masonry.

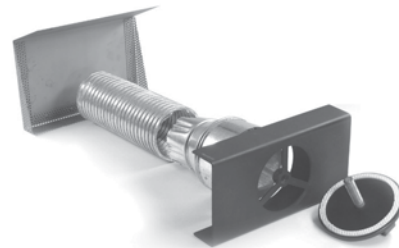

Model No.	Description	Standard	Package	Part Code
		Quantity	Wt. Lbs.	
V 601K	Spin-Air Outside Air Kit	1	5	50-049

VESTAL MANUFACTURING
Sweetwater, TN 37874
800-456-9562

**Order by
the Pallet!**

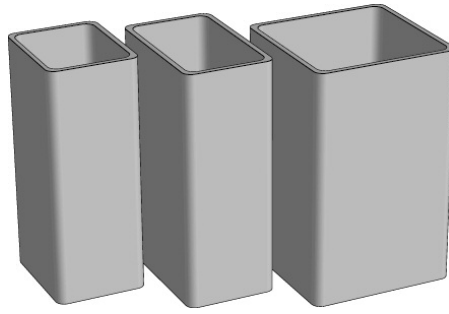

**Increase
inventory
turns!**

MASONRY CLAY FLUE LINER

Model #	O.D.	Description	Pallet Qty.	Weight	Pallet Wt.	Part Codes
FL-88	8 x 8	Clay Flue Liner	84	32	2688	50-057
FL-8585	8.5 x 8.5	Clay Flue Liner	84	33	2772	50-058
FL-812	8 x 12	Clay Flue Liner	60	50	3000	50-059
FL-8513	8.5 x 13	Clay Flue Liner	60	55	3300	50-060
FL-1212	12 x 12	Clay Flue Liner	40	60	2400	50-061
FL-1313	13 x 13	Clay Flue Liner	40	71	2840	50-062
FL-8518	8.5 x 18	Clay Flue Liner	36	92	3312	50-063
FL-1216	11.5 x 15.5	Clay Flue Liner	32	88	2816	50-064
FL-1318	13 x 18	Clay Flue Liner	24	102	2448	50-065
FL-1616	15.5 x 15.5	Clay Flue Liner	24	120	2880	50-066
FL-1818	18 x 18	Clay Flue Liner	18	144	2592	50-067
FL-1620	16 x 20	Clay Flue Liner	18	142	2556	50-068
FL-2020	19.5 x 19.5	Clay Flue Liner	18	170	3060	50-069
FL-2024	19.5 x 23.5	Clay Flue Liner	18	217	3906	50-070
FL-2424	24 x 24	Clay Flue Liner	12	263	3156	50-071

All flue liner measurements are outside dimensions.

All flue liners are sold in pallet quantities only.

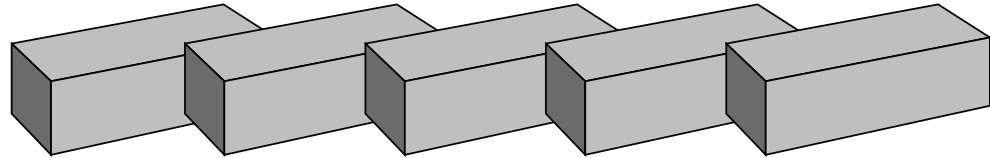

FIRE BRICK

Model #	Description	Cube Qty.	Weight	Cube Wt.	Part Codes
SB-1	Small Fire Brick 9 x 4 x 2.25	400	6	2400	50-040
LB-1	Large Fire Brick 9 x 4.5 x 2.5	300	7	2100	50-041
SPB-1	Split Fire Brick 9 x 4.5 x 1.25	850	4	3400	50-039

All fire bricks are sold in cube quantities only.

FIRE CLAY AND HEAT STOP

Model #	Description	Pallet Qty.	Weight	Pallet Wt.	Part Codes
HS-15	1 Gal. Premix Heat Stop	30 cases (4 per)	15	1800	50-038
FC	50# bag of Fire Clay	40	50	2000	50-042
HS-10	1 Gal. Dry mix Heat Stop Non Water Soluble Outdoor Fireplaces	30 cases (4 per)	10	1200	50-043
HS-50	50# Bag Dry Mix Heat Stop Non Water Soluble Outdoor Fireplaces	48	50	2400	50-044

VESTAL MANUFACTURING
Sweetwater, TN 37874
800-456-9562

CHIMNEY CAPS
FOR CONVENTIONAL FIREPLACES



Model No.	Fits Outside Flue Sizes From - To	Standard Package	Wt. lbs.	Part Code
9 x 9	7½" x 7½" to 9½" x 9½"	1	5	50-025
9 x 13	7½" x 11½" to 9½" x 13½"	1	6	50-026
9 x 18	7½" x 16½" to 9½" x 18½"	1	8	50-027
13 x 13	11½" x 11½" to 13½" x 13½"	1	8	50-028
13 x 18	11½" x 16½" to 13½" x 18½"	1	10	50-029
18 x 18	16½" x 16½" to 18" x 18"	1	13	50-030

* If leg kits are required, specify when ordering. Caps are boxed with screw installation materials only.



Model No.	Description	Standard	Package	Part Code
		Quantity	Wt. lbs.	
SIK-1	Leg Kit	1	2	50-045

*Tri-Mount Chimney Cap converts to "Slip-In" Style Cap by ordering optional leg kit (Model SIK-1).

STAINLESS STEEL CHIMNEY CAPS

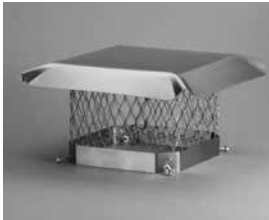

Model No.	Fits Flue Sizes From - To	Standard Package	Wt. lbs.	Part Code
SS99	7½" x 7½" to 9½" x 9½"	1	5	50-032
SS913	7½" x 11½" to 9½" x 13½"	1	6	50-033
SS1313	11½" x 11½" to 13½" x 13½"	1	8	50-035
SS1318	11½" x 16½" to 13½" x 18½"	1	10	50-036
SS1818	16½" x 16½" to 18" x 18"	1	13	50-037

- ◆ 100% stainless steel construction
- ◆ Long lasting protection even with coal burner
- ◆ Slotted cone tipped 100% stainless hex-head bolts
- ◆ Fully assembled - ready to install
- ◆ Fully welded - no rivets to pop loose

TOP SEALING FIREPLACE DAMPER

- Constructed of stainless steel & aluminum
- Energy efficient – seals in A/C & furnace heat
- Replaces leaky throat dampers
- Seals out mammals, birds & insects
- Serves as a chimney cap when closed
- Keeps out rain, snow, sleet & hail
- Easy to open
- Always opens to a pre-set height

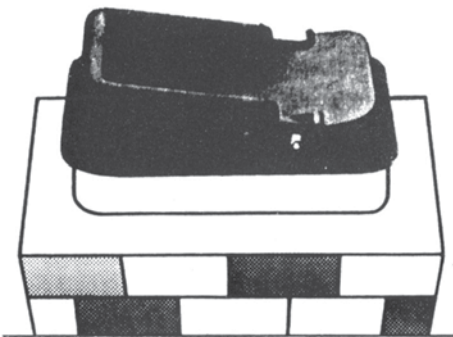

Model No.	Fits Outside Flue Sizes From - To	Standard Package	Wt. lbs.	Part Code
LLY88	6¾" x 6¾" to 9" x 9"	1	6	20-114
LY913	6½" x 10½" to 9" x 12¾"	1	7	20-107
LY1313	10 ^{1/8} " x 10 ^{1/8} " to 12¾" x 12¾"	1	8	20-108
LY1216	9¼" x 13" to 11¾" x 15½"	1	9	20-109
LY1318	9 ^{5/8} " x 15" to 12¾" x 17½"	1	10	20-110
LY1717	15" x 15" to 17¾" x 17¾"	1	11	20-111
LY50	50' Extension Cable	1	1	20-113
LY Kit	Hardware Kit	1	1	20-112

*Standard package includes 30' chain

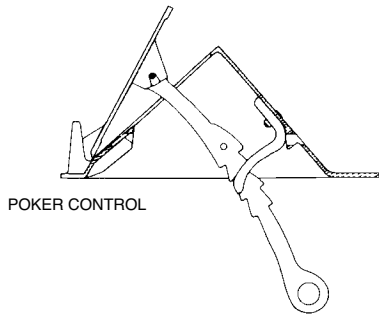

FIREPLACE DAMPER CONTROLS ONLY

Model No.	Description	Standard Quantity	Package Wt. lbs.	Part Code
R-1	Rotary Controls for sizes 24" thru 48"	1	3	15-001
P-3	Poker Controls for sizes 24" thru 72"	1	1½	15-003
C-5	Chain Control	1	¼	15-005
R-130	Rotary Control w/ 30" Rod	1	4	97-085

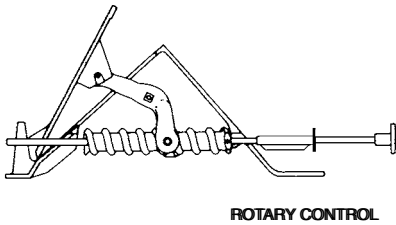

EXPLANATORY NOTES – DAMPER CONTROL

Rotary Controls and Poker Controls are interchangeable on all dampers except Chain Control Dampers and High Throat Dampers (HT series).

DAMPER VALVE PLATE - CAST IRON

Model No.	Length	Width	Weight lbs.	Part Code
24VP	16 5/8"	7"	6	97-010
30VP	22 1/2"	7"	7	97-011
33VP	25"	7"	8	97-012
36VP	28 3/8"	7"	10	97-013
42VP	34 1/2"	7"	11	97-014
48VP	40 3/8"	7"	13	97-015

DAMPER VALVE PLATE - STEEL

Model No.	Length	Width	Weight lbs.	Part Code
324VP	16 5/8"	7"	4	97-019
330VP	22 1/2"	7"	6	97-020
333VP	25"	7"	6	97-021
336VP	28 3/8"	7"	7	97-022
342VP	34 1/2"	7"	8	97-023
348VP	40 3/8"	7"	10	97-024

OLD STYLE VALVE PLATE - STEEL

Model No.	Length	Width	Weight lbs.
54VP-OLD	46 1/2"	7"	18
60VP-OLD	51 1/4"	8"	20
72VP-OLD	30 7/8"	8"	10

NEW STYLE VALVE PLATE - STEEL

Model No.	Length	Width	Weight lbs.
54VP-NEW	24"	7"	11
60VP-NEW	27"	8"	15
72VP-NEW	32 1/2"	8"	10



FIREPLACE DAMPER – POKER CONTROL – ALL CAST IRON



All cast iron dampers 50 per pallet

Model No.	Throat Dimensions			Height	Overall Dimensions			Std. Pkg.	Wt. Ea. lbs.	Part Code
	Front	Back	Depth		Front	Back	Depth			
24	24"	18"	10"	6"	27½"	20"	13½"	1	28	01-001
30	30"	23"	10"	6"	33¾"	26¼"	13½"	1	39	01-002
33	33"	26"	10"	6"	36¼"	29"	13½"	1	42	01-003
36	36"	29"	10"	6"	37¾"	31¼"	13½"	1	45	01-004
42	42"	35"	10"	6"	43¾"	37½"	13½"	1	57	01-005
48	48"	41"	10"	6"	51½"	43½"	13½"	1	65	01-006

FIREPLACE DAMPER - ROTARY CONTROL – ALL CAST IRON

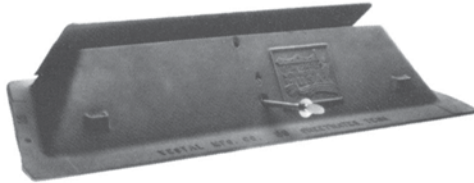

Model No.	Throat Dimensions			Height	Overall Dimensions			Std. Pkg.	Wt. Ea. lbs.	Part Code
	Front	Back	Depth		Front	Back	Depth			
124	24"	18"	10"	6"	27½"	20"	13½"	1	29	01-010
130	30"	23"	10"	6"	33¾"	26¼"	13½"	1	40	01-011
133	33"	26"	10"	6"	36¼"	29"	13½"	1	43	01-012
136	36"	29"	10"	6"	37¾"	31¼"	13½"	1	46	01-013
142	42"	35"	10"	6"	43¾"	37½"	13½"	1	58	01-014
148	48"	41"	10"	6"	51½"	43½"	13½"	1	66	01-015

NOTE: Poker Control and Rotary Control Interchangeable on Cast Iron Dampers.

FIREPLACE DAMPER - CAST IRON BODY STEEL VALVE PLATE - POKER CONTROL



Model No.	Throat Dimensions			Height	Overall Dimensions			Std. Pkg.	Wt. Ea. lbs.	Part Code
	Front	Back	Depth		Front	Back	Depth			
324	24"	18"	10"	6"	27½"	20"	13½"	1	26	02-001
330	30"	23"	10"	6"	33¾"	26¼"	13½"	1	33	02-002
333	33"	26"	10"	6"	36¼"	29"	13½"	1	37	02-003
336	36"	29"	10"	6"	37¾"	31¼"	13½"	1	42	02-004
342	42"	35"	10"	6"	43¾"	37½"	13½"	1	52	02-005
348	48"	41"	10"	6"	51½"	43½"	13½"	1	60	02-006
* 354	54"	47"	10"	6"	59"	53½"	13½"	1	63	02-007
* 360	60"	52"	11½"	6 ^{3/8} "	65½"	58¾"	13½"	1	75	02-008
* 372	72"	64"	11½"	6 ^{3/8} "	76"	70½"	13½"	1	100	02-009

*No UPS, 2 Valve Plates



SPECIALTY DAMPERS

SEALED ENERGY DAMPER

CAST IRON BODY - HEAVY DUTY STEEL VALVE PLATE - POKER CONTROL



Model no.	Throat Dimensions			Height	Overall Dimensions			Std. Pkg.	Wt. Ea. lbs.	Part Code
	Front	Back	Depth		Front	Back	Depth			
E-24	24"	18"	10"	6"	27½"	20"	13½"	1	28	01-041
E-30	30"	23"	10"	6"	33¾"	26¼"	13½"	1	39	01-042
E-33	33"	26"	10"	6"	36¼"	29"	13½"	1	42	01-043
E-36	36"	29"	10"	6"	37¾"	31¼"	13½"	1	45	01-044
E-42	42"	35"	10"	6"	43¾"	37½"	13½"	1	57	01-045
E-48	48"	41"	10"	6"	51½"	43½"	13½"	1	65	01-046

FIREPLACE DAMPER - HIGH THROAT - ALL STEEL

FURNISHED WITH ASSEMBLED AND ATTACHED FOLDING HANDLE

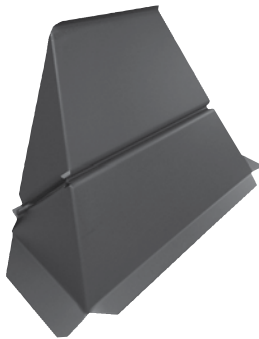

* 20 per pallet

Model no.	Throat Dimensions			Height	Overall Dimensions			Std. Pkg.	Wt. Ea. lbs.	Part Code
	Front	Back	Depth		Front	Back	Depth			
HT-24	24"	24"	8½"	15¾"	27"	27"	10¾"	1	22	05-001
HT-30	30"	30"	8½"	15¾"	33"	33"	10¾"	1	27	05-002
HT-36	36"	36"	8½"	15¾"	39"	39"	10¾"	1	34	05-004
HT-42	42"	42"	8½"	15¾"	45"	45"	10¾"	1	38	05-005
HT-48	48"	48"	8½"	15¾"	51"	51"	10¾"	1	44	05-006

MULTI-OPENING FIREPLACE DAMPER -- ALL STEEL, CHAIN CONTROL

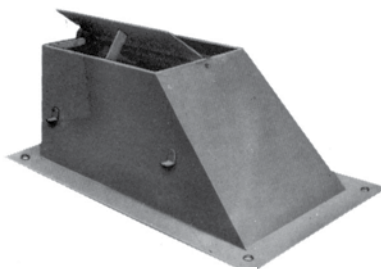

* Nestable 10 high

Model No.	Throat Size	Flue Outlet	Height	Width Lintel	Standard Package	Wt. lbs.	Part Code
3016	30"x16"	13"x18"	13½"	3"	1	46	08-001
3320	33"x20"	18"x18"	16"	3"	1	63	08-002
* 3620	36"x20"	18"x18"	18 ^{5/8} "	3"	1	76	08-003
* 4220	42"x20"	18"x24"	21½"	3"	1	83	08-004
* 4824	48"x24"	20"x24"	21½"	3"	1	100	08-005

Installation Instructions - Multi Opening Damper - For IB-112 - Available on Request

*No UPS

CORNER SUPPORTS FOR MULTI-OPENING FIREPLACE

COMPLETE WITH BEARING PLATES



Model No.	Description	Length	Standard Package	Wt. lbs.	Part Code
CP-20-R	2 3/8" Dia. Round Post	30"	1	12	14-002

VESTAL MANUFACTURING
Sweetwater, TN 37874
800-456-9562



ASH DUMPS

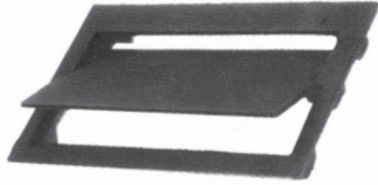

* 60 boxes per pallet

ASH DUMPS - SOLID CAST IRON

Model No.	Size	Standard Package		Part Code
		Quantity	Wt. lbs.	
49	4½" x 9"	12	40	24-001
I-49	4½" x 9" Import	12	40	24-005

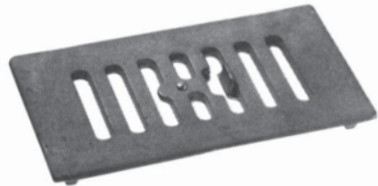

VENTED ASH DUMPS

CAST IRON OR STEEL

Outside air intake controlled by sliding shutter. Controls outside air source from inside the fireplace. Keeps cold air out when not in use. Easy installation.

Model No.	Description	Standard Package		Part Code
		Quantity	Wt. lbs.	
94CIOA	Cast iron ash dump with outside air - 4½" x 9"	12	46	24-015
94OA	Steel ash dump with outside air - 4½" x 9"	6	25	24-010



ASH CADDY

CAST IRON GRILLE - GALVANIZED INNER PAIL

Model No.	Top Grille Size	Pail Size		Standard Package		Part Code
		Top	Depth	Quantity	Wt. lbs.	
AC	9½"x9½"	9"x9"	7"	6	45	24-004





CLEANOUT DOORS



* 60 boxes per pallet

CLEANOUT DOOR -- SOLID CAST IRON

Model No.	Width By Height	Standard Package		Part Code
		Quantity	Wt. lbs.	
* H-88	8" X 8"	6	46	26-001
I-88	8" X 8" Import	6	40	26-002
108	10" x 8"	6	56	26-003
128	12" x 8"	6	66	26-004
1210	12" x 10"	4	64	26-005
1212	12" x 12"	4	69	26-006
1612	16" x 12"	3	62	26-008

*Logo included on H-88, 108, & 128 doors

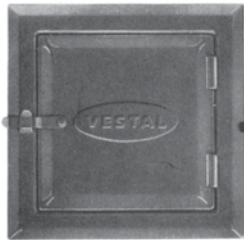

STEEL CLEANOUT DOOR

Model No.	Width By Height	Standard Package		Part Code
		Quantity	Wt. lbs.	
ST-88	8" X 8" Galvanized	6	21	26-011
ST-108	10" X 8" Steel Cleanout	5	22	26-012

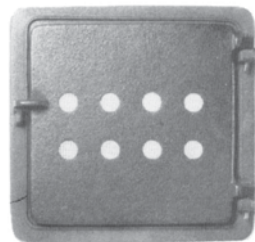

VENTED CAST IRON CLEANOUT DOOR

Model No.	Description	Standard Package		Part Code
		Quantity	Wt. lbs.	
88CIOA	Cast Iron Cleanout Vented for Outside Air 8" x 8"	6	46	26-025



DUTCH OVEN DOOR AND FRAME -- CAST IRON

HINGED LEFT SIDE ONLY

Model No.	Description	Standard Package		Part Code
		Quantity	Wt. lbs.	
DO-12	12½" x 15½"	2	44	27-004
	Door Opening Width by Height			
	11¼" x 14½"			

VESTAL MANUFACTURING
Sweetwater, TN 37874
800-456-9562



FOUNDATION VENTS

VESTAL MANUFACTURING offers a complete line of foundation vents for your building material needs. Plastic vents are offered with sliding shutter. Thermo-vents, constructed of high density thermoplastic, automatically open and close. Stamped aluminum vents are available in 12 gauge or 18 gauge. Aluminum brick vents with fixed louvers replace one or two brick. Block vents are 3-hinged louvered and adjustable.



Model	Width by Height	Description	Net Free Air	Standard Package		Part Code
				Quantity	Wt. lbs.	
DP-D	16" x 8"	Black Plastic Manual Damper	68 sq. in.	8	13	37-012
DP-O	16" x 8"	Black Plastic Open	68 sq. in.	9	7	37-013

- Easy screw in installation; No mortar needed
- Used as new construction or replacement vent
- USA made

FOUNDATION VENTILATOR

Heavy-duty die cast aluminum



Model No.	Width by Height	Description	Standard Package		Part Code
			Quantity	Wt. lbs.	
VFC-5	16" x 8"	Mesh screen with sliding shutter. Built-on lintel	12	32	37-016

45 sq. in. Net Free Air

FOUNDATION VENTILATOR

Heavy-duty die cast aluminum

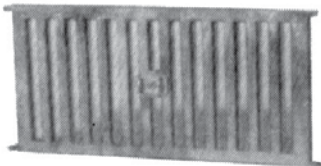

Model No.	Width by Height	Description	Standard Package		Part Code
			Quantity	Wt. lbs.	
VA-19	16" x 8"	Die Cast Vent 42 Sq. In. Net Free Air	12	30	37-031

STAMPED ALUMINUM VENT WITH SCREEN & SHUTTER



Model No.	Width by Height	Description	Standard Package		Part Code
			Quantity	Wt. lbs.	
168	16" x 8"	Approx. 18 ga. Screen & Shutter	12	11	37-008
H-168	16" x 8"	Approx. 12 ga. Screen & Shutter	12	18	37-010

35.5 Sq. In. Net Free Air

LOUVER BLOCK VENT

Adjustable Louvers 8 X 16 Perma-Coated Screen Attached

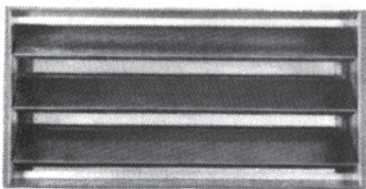

Model No.	Description	Standard Package		Part Code
		Quantity	Wt. lbs.	
GA-168	8"x16" 3-hinged louvers adjustable	12	28	37-015

82 Sq. In. Net Free Air



FOUNDATION VENT
Plastic with Built-On Lintel

Model No.	Description	Standard Package		Part Code
		Quantity	Wt. lbs.	
P-86-L	16" x 8" 1/8" Mesh Aluminum Screen	12	13	37-002

75 sq. in. Net Free Air

FOUNDATION VENTILATOR
Plastic with Built-On Lintel

Model No.	Width by Height	Description	Standard Package		Part Code
			Quantity	Wt. lbs.	
P-68 Black	16" x 8"	Screen and Sliding Shutter	12	18	37-003
P-68 Brown	16" x 8"	Screen and Sliding Shutter	12	18	37-004
P-68 Gray	16" x 8"	Screen and Sliding Shutter	12	18	37-005

44 sq. in. Net Free Air

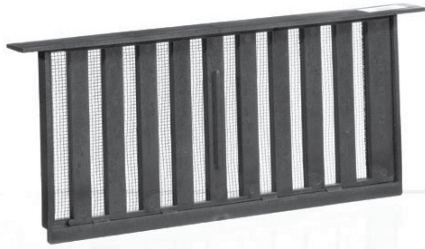

JUMBO FOUNDATION VENTILATORS
Plastic with Built-On Lintel
DESIGNED FOR KING & QUEEN RACK

Model No.	Width by Height	Description	Standard Package		Part Code
			Quantity	Wt. lbs.	
P-68 Black Jumbo	16" x 9.25"	Screen and Sliding Shutter	12	18	37-006
P-68 Brown Jumbo	16" x 9.25"	Screen and Sliding Shutter	12	18	37-011

60 sq. in. Net Free Air

**NEW CONSTRUCTION & REPLACEMENT
FOUNDATION THERMO-VENT**

Automatically opens at 70° and closes at 40° (approx.)

Model No.	Description	Standard Package		Part Code
		Quantity	Wt. lbs.	
PT-816	16" x 8" Black Thermo Plastic	10	15	37-040
PT-816	16" x 8" Brown Thermo Plastic	10	15	37-041
PT-816	16" x 8" Gray Thermo Plastic	10	15	37-042

60 sq. in. Net Free Air

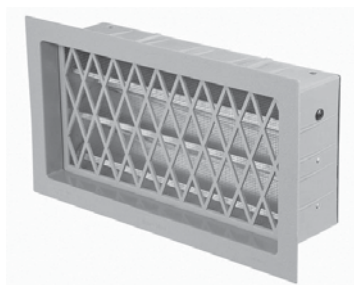

PT-816

The key working mechanism, the bi-metal coil, is **fully enclosed** in a **patented protective cover** relieving maintenance headaches

- Fits standard 8" x 16" openings.
- High density thermo plastic construction.
- Stainless steel and corrosion resistant metal parts.
- Color: Black, Brown or Gray
- No electrical hook-up.
- Heavy duty aluminum mesh screen - front and back.

VESTAL MANUFACTURING
Sweetwater, TN 37874
800-456-9562

FLOOD FLAP

- ICC-ES Evaluated ESR-3560
- FEMA Compliant
- Each engineered vent cover provides 220 sq. ft. of flood protection
- No preventative maintenance required

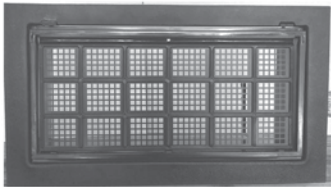

Multi-Purpose Vent Series

Flood Flaps® Multi-Purpose Series vents are certified to provide flood protection and air ventilation. These FEMA compliant models are perfectly designed for an enclosure or crawl space in a flood plain that desires natural air while still providing efficient flood relief when necessary. The patented grill remains closed and secure until forced open by flood waters, allowing water to enter or exit the enclosed area. Certified flood debris clearance is validated with a 5.75" opening when the grill is activated.

Model No.	Width by Height	Depth	Description	Standard Package		Part Code
				Quantity	Wt. lbs.	
Flood Flap	15-5/8" x 7-3/4"	5	Flood Vent With Flange Black Plastic	1	4	37-050

POWERED CRAWLSPACE VENT

Model No.	Overall Size (in.)	Opening Size (in.)	Cubic Feet Vent Ventilates	Number Per Carton	Weight Per Carton (lbs.)	Part Code
VPCVI	9" x 19" x 3"	8" x 16"	1650	6	28	37-043



Specifications:

- Quiet 110 Cfm Ball Bearing Motor
- Dries Crawlspace Gradually
- Humidity Sensor for Worry-Free Operation
- Thermostat Shuts Fan Off at Low Temperatures
- U.L. Approved Means Assured Safety
- Can Help Stop Mold Growth
- Upgrades Your Present Foundation Vent
- Easy Installation in a Variety of Constructions
- Mounts Behind Foundation Vent for Invisible Operation
- Quick and Simple Solution for Underventilated Crawlspace

ALUMINUM BRICK VENT

FIXED LOUVERS -- 8x8 PERMA-COATED SCREEN ATTACHED

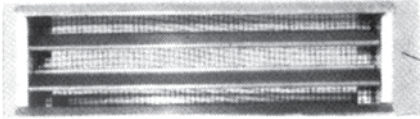

Model No.	Description	Standard Package		Part Code
		Quantity	Wt. lbs.	
AL-1	2 ⁹ / ₁₆ " x 7 ⁷ / ₁₆ " x 3 ⁵ / ₁₆ " Replaces one brick	12	11	37-025
AL-2	5 ¹ / ₁₆ " x 7 ⁷ / ₁₆ " x 3 ⁵ / ₁₆ " Replaces two bricks	12	16	37-035

AL-1 Net Free Air 12.5 Sq. In

AL-2 Net Free Air 23.5 Sq. In

CAST IRON BRICK VENT / SLIDING SHUTTER



Model No.	Description	Standard Package		Part Code
		Quantity	Wt. lbs.	
V364	8.25" x 2.5" x 2.75"	12	48	37-020

VESTAL'S FOUNDATION ACCESS DOORS

FEATURES

- *Heavy gauge steel all-welded construction*
- *All Vestal crawl space doors accept locking mechanism*
- *New heavier built-on lintel for strength*
- *Door size is stenciled on each door*
- *Primed with black corrosion resistant paint*
- *Available in eight sizes*
- *Insulated door provides R factor of 3.8*



STEEL CRAWL SPACE DOORS - BUILT ON LINTEL

Model Number	Weight	W x H	Standard Package	Pallet Qty.	Part Code
CL-2416	11#	24" x 16"	1	40	83-015
CL-2424	13#	24" x 24"	1	20	83-016
CL-3216	13#	32" x 16"	1	40	83-017
CL-3220	16#	32" x 20"	1	40	83-018
CL-3224	17#	32" x 24"	1	40	83-019
CL-3232	18#	32" x 32"	1	20	83-020
CL-3240	20#	32" x 40"	1	20	83-021
CL-3624	21#	36" x 24"	1	40	83-022
*INS-CL-3224	22#	32" x 24"	1	20	83-045

*Insulated Access Door

VESTAL MANUFACTURING

Sweetwater, TN 37874

800-456-9562

METAL LATH

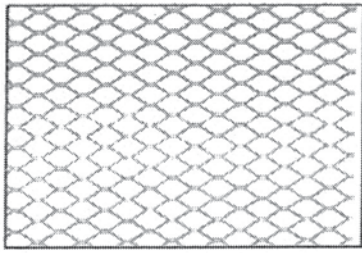

Galvanized Metal Lath

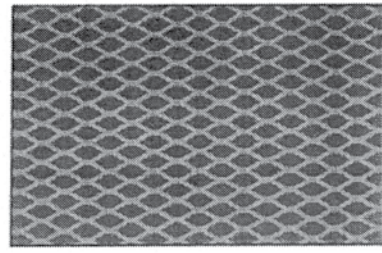

Paper Back Galvanized Metal Lath

Model No.	Description	Sheet Size	Pieces/ Bundle	Pallet Quantity	Weight/ Pallet	Part Code
2.5 Flat	Self Furring Galvanized Metal Lath	27" x 96"	10	250	1250	85-001
2.5 Paper	Paper Back Galv. Metal Lath	27" x 96"	10	250	1250	85-002

*Metal lath sold in pallet quantities only.



FOUNDATION VENT WINDOW WELL – GALVANIZED STEEL

Model No.	Size	Standard Package		Part Code
	Width 20"	Quantity	Wt. lbs.	
R-207	Projection 7"	6	20	90-001
	Height 12"			



ROUND WINDOW WELL – GALVANIZED STEEL

Model No.	Inside Width	Projection	Height	Standard Package		Part Code
				Quantity	Wt. lbs	
R18-12	37"	16"	12"	4	30	90-006
R18-18	37"	16"	18"	4	45	90-007
R18-24	37"	16"	24"	3	46	90-008
R18-30	37"	16"	30"	3	56	90-009
* R18-36	37"	16"	36"	3	69	90-010

*No UPS

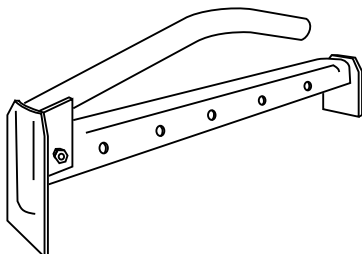

ADJUSTABLE STEEL BRICK CLAMPS*

Model No.	Type	Adjustment Size	Standard Package		Part Code
			Quantity	Wt. lbs	
SC-2	Steel	14" to 24"	4	18	49-010

*QUICK RELEASE PIN DESIGN



WALL TIES – STRAIGHT SIDE STYLE – “SPACE SAVER” CARTON

Model No.	Size	Gauge	Approx. Pcs. Per Carton	Approx. Wt. Per Carton	Part Code
S-28	7 ¹ / ₈ " x 6 ³ / ₈ "	28	1000	29 lbs.	86-001
S-22	7 ¹ / ₈ " x 6 ³ / ₈ "	22	500	22 lbs.	86-002
S-26	7 ¹ / ₈ " x 6 ³ / ₈ "	26	500	20lbs.	86-006

28 gauge carton separates into two approximately 500 piece cartons
 26 gauge carton separates into two approximately 250 piece cartons
 22 gauge carton separates into two approximately 250 piece cartons



WALL TIES – HERRINGBONE STYLE – “SPACE SAVER” CARTON

Model No.	Size	Gauge	Approx. Pcs. Per Carton	Approx. Wt. Per Carton	Part Code
H-28	7 ¹ / ₈ " x 6 ³ / ₈ "	28	1000	20 lbs.	86-003
H-22	7 ¹ / ₈ " x 6 ³ / ₈ "	22	500	17 lbs.	86-004

28 gauge carton separates into two approximately 500 piece cartons
 22 gauge carton separates into two approximately 250 piece cartons

* 28 Ga. Ties - 144 Boxes Per Pallet
 26 Ga. Ties - 200 Boxes Per Pallet
 22 Ga. Ties - 160 Boxes Per Pallet



WALL TIES – STRAIGHT STYLE – “100 PACK” CARTON

Model No.	Size	Gauge	Approx. Pcs. Per Carton	Master Carton	Approx. Wt. Per Carton	Part Code
S-22 (100 pack)	7 ¹ / ₈ " x 6 ³ / ₈ "	22	100	1000	48 lbs.	86-005

*50 master cartons per pallet

MORTAR BOX – STEEL – NESTABLE

One Piece Construction



Model No.	Capacity Cu. Ft.	Inside At Top	Depth	Standard Package		Part Code
				Quantity	Wt. lbs	
6	6	26" x 47 ¹ / ₂ "	12"	1	47	89-001
9	9	30" x 58"	12"	1	64	89-002
15	15	36" x 75"	12"	1	80	89-003
18	18	36" x 86"	12"	1	120	89-005

STEEL MORTAR PAN

Seamless Steel Construction – Nestable – Baked on Blue Enamel

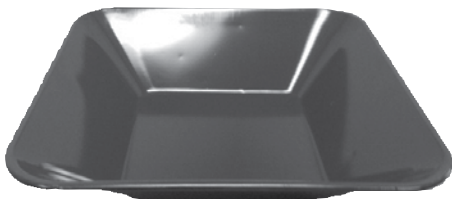

Model No.	Capacity Cu. Ft.	Dimensions Inside At Top	Standard Package		Part Code
			Quantity	Wt. lbs	
M-1	3	29 ¹ / ₂ " x 29 ¹ / ₂ "	1	16	89-006

VESTAL MANUFACTURING

Sweetwater, TN 37874

800-456-9562

1/2" ANCHOR BOLT – WITH NUT AND WASHER
50 PER BOX (PRICED IN QUANTITIES OF 100)

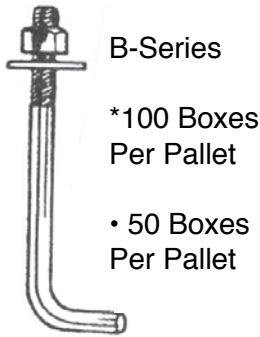

Model No.	Size	Standard Package		Part Code
		Quantity	Wt. lbs	
* B-6	1/2" x 6"	50	17	88-020
* B-8	1/2" x 8"	50	21	88-021
* B-10	1/2" x 10"	50	25	88-022
* B-12	1/2" x 12"	50	30	88-023
• B-14	1/2" x 14"	50	34	88-024
• B-16	1/2" x 16"	50	38	88-025
• B-18	1/2" x 18"	50	43	88-026

1/2" GALVANIZED ANCHOR BOLT W/ NUT AND WASHER
50 PER BOX (PRICED IN QUANTITIES OF 100)

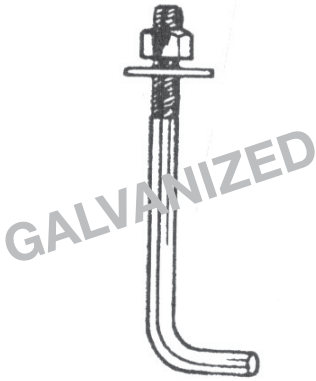

Model No.	Size	Standard Package		Part Code
		Quantity	Wt. lbs	
* B-6	1/2" x 6"	50	18	88-001
* B-8	1/2" x 8"	50	22	88-002
* B-10	1/2" x 10"	50	26	88-003
* B-12	1/2" x 12"	50	31	88-004
• B-14	1/2" x 14"	50	35	88-005
• B-16	1/2" x 16"	50	39	88-006
• B-18	1/2" x 18"	50	44	88-007

FOUNDATION ANCHORS*

Eliminates plate drilling - Also used as rafter tie

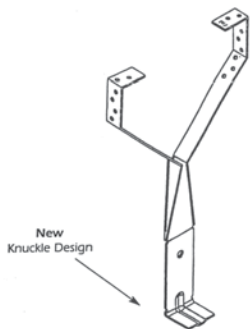

Model No.	Description	Standard Package		Part Code
		Quantity	Wt. lbs	
VFA3Z-14	For masonry embedment 14 3/4" x 18 gauge	50	14	88-039
VFA3Z-22	For masonry embedment 22 3/4" x 18 gauge	50	21	88-040

VFA3Z-14 = 150 Cartons per pallet

VFA3Z-22 = 100 Cartons per pallet

*Foundation anchors are code approved.

REBAR CHAIRS

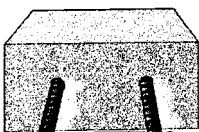

2-BAR

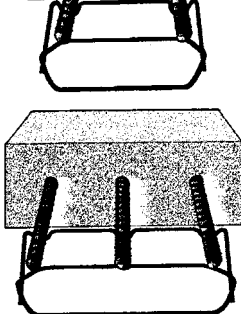

3-BAR

Model No.	Description	Size	Std. Package	Wt.	Part Code
VRC-2	2-Bar Rebar Support	4" H x 8.5" W	100/box	12	88-041
VRC-3	3-Bar Rebar Support	4" H x 12" W	100/box	18	88-042

- Designed to hold rebar off grade in foundations.
- Code required in many areas.
- Fast, convenient, and easy to use.
- Designed for use with numbers 4, 5, 6 rebar.
- Imported



FLEXA POST

2 3/4" BOTTOM TUBE - 2 1/2" TOP - 2 PIN LOCK - TELESCOPING JACK POST WITH STEEL NUT AND STEEL SCREW. TOP AND BOTTOM TUBE 14 GAUGE.

Model No.	Description	Standard Package		Part Code
		Quantity	Wt. lbs	
1	4' 8" - 8' 4"	1	23	72-001

FLEXA POST

2 1/2" BOTTOM TUBE - 14 GAUGE - 2 1/4" TOP TUBE - 16 GAUGE - 2 PIN LOCK 1" SCREW WITH STEEL NUT.

Model No.	Description	Standard Package		Part Code
		Quantity	Wt. lbs	
11	4' 8" - 8' 4"	1	19	72-006
12	4' 5" - 7' 9"	1	17	72-007
14	2' 10" - 4' 7"	1	13	72-009
15	1' 7" - 3' 0"	1	9	72-008
16	1' 0" - 1' 4"	2	9	72-010

*"Thanks For Buying
... American Products"*



SCREW ADJUSTMENT ASSEMBLY

CAST IRON NUT - SCREW CUT STEEL THREADS

Model No.	For	Standard Package		Part Code
		Quantity	Wt. lbs	
SCA-3A	3" O.D. Tube with Attached Plate	1	5	73-010
SCA-4A	4" O.D. Tube with Attached Plate	1	8	73-011

CAP OR BASE FOR STEEL POST

FOR 3" OR 4" TUBE

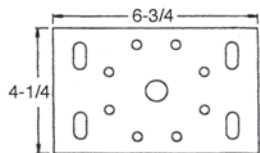

P56

Model No.	For	Size	Standard Package		Part Code
			Quantity	Wt. lbs	
P56	3" O.D. Tube	4 1/4" x 6 3/4" x 1/4"	1	2	73-007
	4" O.D. Tube				

VESTAL MANUFACTURING

Sweetwater, TN 37874

800-456-9562

EXPANDA POST – 3” O.D. BY 11 GA. – ADJUSTABLE LENGTH

Model No.	Adjustable From To	Design Load (Pounds)	Wt. lbs.	Part Code
760	6' 0" to 6' 4"	13,993	28	70-015
763	6' 3" to 6' 7"	13,641	29	70-016
766	6' 6" to 6' 10"	13,345	30	70-017
769	6' 9" to 7' 1"	13,044	31	70-001
770	7' 0" to 7' 4"	12,740	32	70-002
773	7' 3" to 7' 7"	12,432	33	70-003
776	7' 6" to 7' 10"	12,122	34	70-004
779	7' 9" to 8' 1"	11,810	35	70-005
780	8' 0" to 8' 4"	11,497	36	70-006
783	8' 3" to 8' 7"	11,183	37	70-007
786	8' 6" to 8' 10"	10,868	38	70-008
789	8' 9" to 9' 1"	10,554	39	70-009
790	9' 0" to 9' 4"	10,240	40	70-010
793	9' 3" to 9' 7"	9,928	41	70-011
796	9' 6" to 9' 10"	9,617	42	70-012
799	9' 9" to 10' 1"	9,309	43	70-013
7100	10' 0" to 10' 4"	9,003	44	70-014

* 24 POSTS PER BUNDLE



EXPANDA POST – 4” O.D. BY 11 GA. – ADJUSTABLE LENGTH

Model No.	Adjustable From To	Design Load (Pounds)	Wt. lbs.	Part Code
960	6' 0" to 6' 4"	21,105	39	70-024
963	6' 3" to 6' 7"	20,860	40	70-025
966	6' 6" to 6' 10"	20,608	41	70-026
969	6' 9" to 7' 1"	20,351	42	70-027
970	7' 0" to 7' 4"	20,087	43	70-028
973	7' 3" to 7' 7"	19,818	45	70-029
976	7' 6" to 7' 10"	19,544	46	70-030
979	7' 9" to 8' 1"	19,265	47	70-031
980	8' 0" to 8' 4"	19,981	48	70-032
983	8' 3" to 8' 7"	19,693	49	70-033
986	8' 6" to 8' 10"	18,401	51	70-034
989	8' 9" to 9' 1"	18,105	52	70-035
990	9' 0" to 9' 4"	17,806	53	70-036
993	9' 3" to 9' 7"	17,504	54	70-037
996	9' 6" to 9' 10"	17,200	55	70-038
999	9' 9" to 10' 1"	16,893	56	70-039
9100	10' 0" to 10' 4"	16,584	59	70-040

* 24 POSTS PER BUNDLE

All Dura Post and Expanda Post furnished with Cap and Base.

All structural steel posts have been given a shop coat of rust-inhibitive paint inside and outside. A field coat of protective paint may be necessary in some cases. Labels are Bar Coded.



DURA POST – 3” BY 11 GA. – FIXED LENGTH

COMPLIES WITH FHA/HUD STANDARDS

Model No.	Overall Length	Design Load (Pounds)	Standard Package		Part Code
			Quantity	Wt. lbs	
380	8' 0"	11,914	1	34	71-006
390	9' 0"	10,659	1	37	71-008
3100	10' 0"	9,411	1	41	71-010

* 24 POSTS PER BUNDLE

DURA POST – 4” BY 11 GA. – FIXED LENGTH

COMPLIES WITH FHA/HUD STANDARDS

Model No.	Overall Length	Design Load (Pounds)	Standard Package		Part Code
			Quantity	Wt. lbs	
580	8' 0"	19,358	1	44	71-028
590	9' 0"	18,204	1	49	71-030
5100	10' 0"	16,996	1	53	71-032
5120	12' 0"	14,496	1	62	71-040

* 24 POSTS PER BUNDLE

All Dura Post and Expanda Post furnished with Cap and Base.

All structural steel posts have been given a shop coat of rust-inhibitive paint inside and outside. A field coat of protective paint may be necessary in some cases. Labels are Bar Coded.

VESTAL MANUFACTURING

Sweetwater, TN 37874

800-456-9562



*"Thanks For Buying
... American Products"*

GALVANIZED FOUNDATION VENT LINTELS

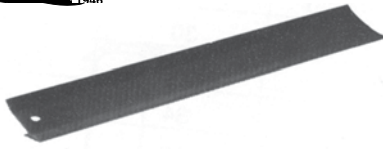

Model No.	Size	Standard Package		Part Code
		Quantity	Wt. lbs	
203	20" x 3"	25	28	51-007

Pallet Quantity: 2100



EXTRA CRIMP ON ALL BRICK LINTELS FOR ADDED STRENGTH



ALL BRICK AND BLOCK LINTELS PAINTED.



TOP LINTEL OF EACH BUNDLE IS MARKED PER SIZE.

GALVANIZED FORMED STEEL BRICK LINTELS

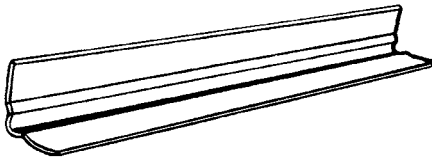

Model No.	Description	Size	Standard	Package	Part Code
			Quantity	Weight	
G-24	24" F/S Galvanized Lintel	3½ x 3½	1	4	51-030
G-30	30" F/S Galvanized Lintel	3½ x 3½	1	5	51-031
G-36	36" F/S Galvanized Lintel	3½ x 3½	1	6	51-032
G-42	42" F/S Galvanized Lintel	3½ x 3½	1	7	51-033
G-48	48" F/S Galvanized Lintel	3½ x 3½	1	9	51-034
G-54	54" F/S Galvanized Lintel	3½ x 3½	1	10	51-035
G-60	60" F/S Galvanized Lintel	3½ x 3½	1	11	51-036
G-66	66" F/S Galvanized Lintel	3½ x 4½	1	19	51-037
G-72	72" F/S Galvanized Lintel	3½ x 4½	1	21	51-038
G-78	78" F/S Galvanized Lintel	3½ x 4½	1	23	51-039
G-84	84" F/S Galvanized Lintel	3½ x 4½	1	25	51-040
G-90	90" F/S Galvanized Lintel	3½ x 4½	1	27	51-041
G-96	96" F/S Galvanized Lintel	3½ x 4½	1	28	51-042

* G-24 to G-60 400 pcs. per pallet

* G-66 to G-96 200 pcs. per pallet

FORMED STEEL BRICK LINTELS - 3½" x 3½"

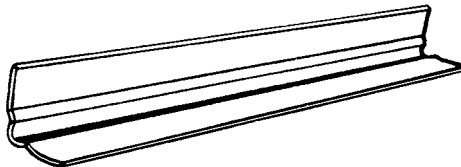

360 pcs. per pallet

Model No.	Size	Standard Package		Part Code
		Quantity	Wt. lbs	
220	24"	6	25	51-001
226	30"	6	31	51-002
230	36"	6	36	51-003
236	42"	6	42	51-004
240	48"	6	49	51-005
246	54"	6	55	51-006
250	60"	6	62	51-008

FORMED STEEL BRICK LINTELS - 3½" x 4½"

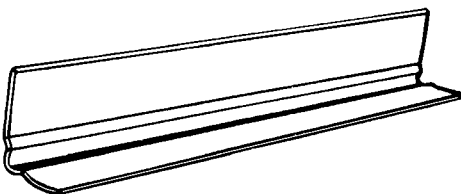

120 pcs. per pallet

Model No.	Size	Standard Package		Part Code
		Quantity	Wt. lbs	
256	66"	3	60	51-009
260	72"	3	67	51-010
266	78"	3	71	51-011
270	84"	3	75	51-012
276	90"	3	80	51-013
280	96"	3	86	51-014

VESTAL MANUFACTURING
Sweetwater, TN 37874
800-456-9562



NOMINAL FORMED STEEL BRICK LINTELS - 3" x 3 1/2"

Model No.	Size	Standard	Package	Part Code
		Quantity	Weight	
320N	24"	6	24	52-001
326N	30"	6	29	52-002
330N	36"	6	35	52-003
336N	42"	6	41	52-004
340N	48"	6	47	52-005
346N	54"	6	53	52-006
350N	60"	6	58	52-007
356N	66"	3	48	52-008
360N	72"	3	53	52-009
366N	78"	3	57	52-010
370N	84"	3	61	52-011
376N	90"	3	66	52-012
380N	96"	3	70	52-013

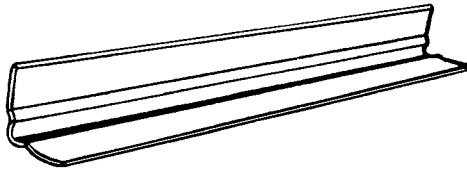

320N - 350N
360 pcs per pallet

356N - 380N
120 pcs per pallet

CONCRETE BLOCK LINTELS - FOR 8" BLOCK

Model No.	Size	Standard	Package	Part Code
		Quantity	Weight	
720	24"	6	39	57-001
726	30"	6	48	57-002
730	36"	6	57	57-003
736	42"	3	33	57-004
740	48"	3	39	57-005
746	54"	3	44	57-006
750	60"	3	48	57-007
756	66"	3	53	57-008
760	72"	3	57	57-009
766	78"	3	63	57-010

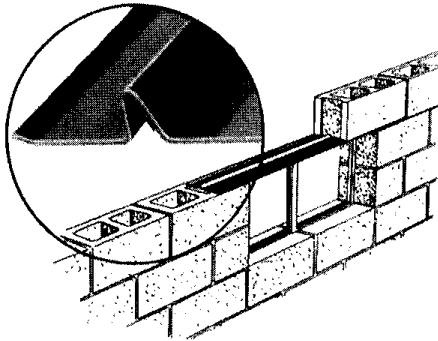

180 pcs. per pallet

RAKE ANGLE

Model No.	Size	Description	Standard Package		Part Code
			Quantity	Wt. lbs	
TPD 10'0"	4"x3"x1/4"	Rake Angle 10'0" Length Painted	1	63	56-600
TPD 20'0"	4"x3"x1/4"	Rake Angle 20'0" Length Painted	1	126	56-610



- Universal design for left and right installation
- Shim Location: 12" from each end and 24" on Center
- Punched Location: 6" from end and 24" on Center
- Punched Size: 1/2"

VESTAL MANUFACTURING
Sweetwater, TN 37874
800-456-9562

STEEL ANGLE 3" x 3" x 3/16"

S 3'0" - S 6'0"
250 pcs. per pallet

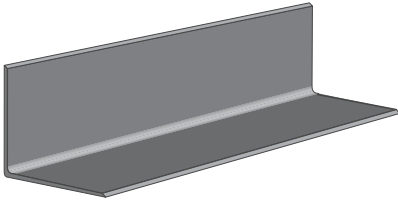

Model No.	Size	Standard	Package	Part Code
		Quantity	Weight	
S 3'0"	3' 0"	1	11	54-003
S 3'6"	3' 6"	1	13	54-004
S 4'0"	4' 0"	1	15	54-005
S 4'6"	4' 6"	1	17	54-006
S 5'0"	5' 0"	1	19	54-007
S 5'6"	5' 6"	1	20	54-008
S 6'0"	6' 0"	1	22	54-009
SPECIAL LENGTHS - Less than 20'			Wt. Per Ft. 3.7	54-010
MILL LENGTHS - 20'			Wt. Per Ft. 3.7	54-011

***CERTAIN ANGLE LENGTHS CAN BE PAINTED OR PUNCHED FOR MINIMUM CHARGE - PLEASE SPECIFY WHEN ORDERING**

STEEL ANGLE 3" x 3½" x 1/4"

A 2'0" - A 4'0"
200 pcs. per pallet

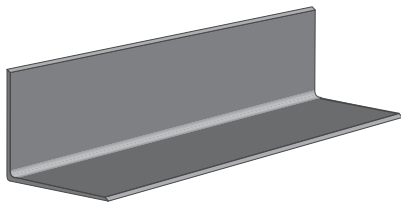

A 4'6" - A 7'0"
100 pcs. per pallet

Model No.	Size	Standard	Package	Part Code
		Quantity	Weight	
A 2'0"	2' 0"	1	11	55-001
A 2'6"	2' 6"	1	14	55-002
A 3'0"	3' 0"	1	16	55-003
A 3'6"	3' 6"	1	19	55-004
A 4'0"	4' 0"	1	22	55-005
A 4'6"	4' 6"	1	24	55-006
A 5'0"	5' 0"	1	27	55-007
A 5'6"	5' 6"	1	30	55-008
A 6'0"	6' 0"	1	32	55-009
A 6'6"	6' 6"	1	35	55-010
A 7'0"	7' 0"	1	38	55-011
A 8'0"	8' 0"	1	43	55-013
A 9'0"	9' 0"	1	49	55-015
A 9'6"	9' 6"	1	51	55-016
A 10'0"	10' 0"	1	54	55-017
SPECIAL LENGTHS - Less than 20'			Wt. Per Ft. 5.4	55-018
MILL LENGTHS - 20'			Wt. Per Ft. 5.4	55-019

***CERTAIN ANGLE LENGTHS CAN BE PAINTED OR PUNCHED FOR MINIMUM CHARGE - PLEASE SPECIFY WHEN ORDERING**

STEEL ANGLE 3½" x 3½" x ¼"

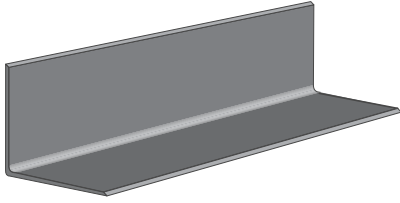

C 2'0" - C 4'0"
200 pcs. per pallet

C 4'6" - C 7'0"
100 pcs. per pallet

Model No.	Size	Standard	Package	Part Code
		Quantity	Weight	
C 2'0"	2' 0"	1	12	56-050
C 2'6"	2' 6"	1	15	56-051
C 3'0"	3' 0"	1	18	56-052
C 3'6"	3' 6"	1	21	56-053
C 4'0"	4' 0"	1	24	56-054
C 4'6"	4' 6"	1	27	56-055
C 5'0"	5' 0"	1	29	56-056
C 5'6"	5' 6"	1	32	56-057
C 6'0"	6' 0"	1	35	56-058
C 6'6"	6' 6"	1	38	56-059
C 7'0"	7' 0"	1	41	56-060
C 7'6"	7' 6"	1	44	56-061
C 8'0"	8' 0"	1	47	56-062
C 8'6"	8' 6"	1	50	56-063
C 9'0"	9' 0"	1	53	56-064
C 9'6"	9' 6"	1	56	56-065
C 10'0"	10' 0"	1	58	56-066
SPECIAL LENGTHS - Less than 20'			Wt. Per Ft. 5.8	56-087
MILL LENGTHS - 20'			Wt. Per Ft. 5.8	56-086

***CERTAIN ANGLE LENGTHS CAN BE PAINTED OR PUNCHED FOR MINIMUM CHARGE - PLEASE SPECIFY WHEN ORDERING**

STEEL ANGLE 4" x 3" x ¼"

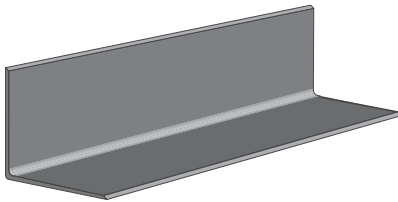

D 2'0" - D 4'0"
200 pcs. per pallet

D 4'6" - D 7'0"
100 pcs. per pallet

Model No.	Size	Standard	Package	Part Code
		Quantity	Weight	
D 2'0"	2' 0"	1	12	55-050
D 2'6"	2' 6"	1	15	55-051
D 3'0"	3' 0"	1	18	55-052
D 3'6"	3' 6"	1	21	55-053
D 4'0"	4' 0"	1	24	55-054
D 4'6"	4' 6"	1	27	55-055
D 5'0"	5' 0"	1	29	55-056
D 5'6"	5' 6"	1	32	55-057
D 6'0"	6' 0"	1	35	55-058
D 6'6"	6' 6"	1	38	55-059
D 7'0"	7' 0"	1	41	55-060
D 7'6"	7' 6"	1	44	55-061
D 8'0"	8' 0"	1	47	55-062
D 8'6"	8' 6"	1	50	55-063
D 9'0"	9' 0"	1	53	55-064
D 9'6"	9' 6"	1	56	55-065
D 10'0"	10' 0"	1	58	55-066
SPECIAL LENGTHS - Less than 20'			Wt. Per Ft. 5.8	55-087
MILL LENGTHS - 20'			Wt. Per Ft. 5.8	55-085

***CERTAIN ANGLE LENGTHS CAN BE PAINTED OR PUNCHED FOR MINIMUM CHARGE - PLEASE SPECIFY WHEN ORDERING**

VESTAL MANUFACTURING
Sweetwater, TN 37874
800-456-9562

PAINTED STEEL ANGLE 5" x 3½" x 1/4"

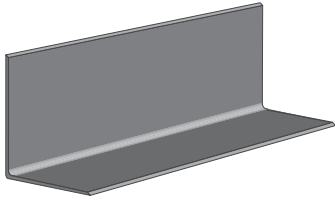

L B 2'0" - L B 4'0" Painted
200 pcs. per pallet

L B 4'6" - L B 7'0" Painted
100 pcs. per pallet

Model	Size	Standard	Package	Part Code
		Quantity	Wt. lbs.	
L B 6'0"	6' 0"	1	42	56-208
L B 7'0"	7' 0"	1	49	56-210
L B 8'0"	8' 0"	1	56	56-212
L B 9'0"	9' 0"	1	63	56-214
L B 10'0"	10' 0"	1	70	56-216
L B 11'0"	11' 0"	1	77	56-218
L B 12'0"	12' 0"	1	84	56-220
L B 13'0"	13' 0"	1	91	56-222
L B 14'0"	14' 0"	1	98	56-224
L B 15'0"	15' 0"	1	105	56-226
L B 16'0"	16' 0"	1	112	56-228
L B 17'0"	17' 0"	1	119	56-230
L B 18'0"	18' 0"	1	126	56-232
L B 19'0"	19' 0"	1	133	56-234
L B 20'0"	20' 0"	1	140	56-236
SPECIAL LENGTHS - Less than 20 ft. Painted			Wt. Per	56-237
			Ft. 7.0	
MILL LENGTHS - 20 ft. Painted			Wt. Per	56-236
			Ft. 7.0	

*CERTAIN ANGLE LENGTHS CAN BE PUNCHED FOR MINIMUM CHARGE -
PLEASE SPECIFY WHEN ORDERING - *ALL L B STEEL LENGTHS COME PAINTED*

STEEL ANGLE 5" x 3½" x 5/16"

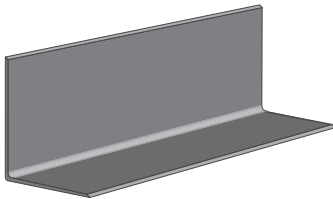

B 2'0" - B 4'0"
200 pcs. per pallet

B 4'6" - B 7'0"
100 pcs. per pallet

Model No.	Size	Standard	Package	Part Code
		Quantity	Weight	
B 6'0"	6'0"	1	52	56-001
B 7'0"	7'0"	1	61	56-003
B 8'0"	8'0"	1	70	56-005
B 9'0"	9'0"	1	78	56-007
B 10'0"	10'0"	1	87	56-009
B 11'0"	11'0"	1	96	56-011
B 12'0"	12'0"	1	104	56-013
B 13'0"	13'0"	1	113	56-015
B 14'0"	14'0"	1	122	56-017
B 15'0"	15'0"	1	131	56-021
B 16'0"	16'0"	1	139	56-023
B 17'0"	17'0"	1	149	56-025
B 18'0"	18'0"	1	157	56-027
B 19'0"	19'0"	1	165	56-029
B 20'0"	20'0"	1	174	56-031
SPECIAL LENGTHS - Less than 20'			Wt. Per Ft. 8.7	56-018
MILL LENGTHS - 20'			Wt. Per Ft. 8.7	56-019

OUTDOOR FIREPLACE GRATES – CAST IRON
FOR DO-IT-YOURSELF BARBECUE UNITS



Model No.	Description	Size	Standard Package		Part Code
			Quantity	Weight	
16-G*	Grated	11 ³ / ₄ " x 16 ¹ / ₂ "	1	10	28-004
24-G	Grated	11 ⁷ / ₈ " x 23 ⁵ / ₈ "	4	50	28-005

* Replacement Grates For OF-56

ROUND HEAVY FRAMES

CAST IRON

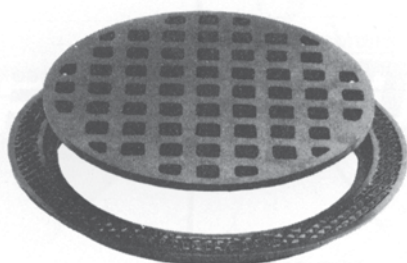

Model No.	Frame Height	Frame Diameter	Standard Package		Part Code Frame
			Quantity	Wt. lbs	
R12-F	2"	16"	1	20	34-005

ROUND HEAVY COVERS

Model No.	Cover Diameter	Standard Package		Part Code Grated Cover
		Quantity	Wt. lbs	
R12-G	12"	1	20	34-017

SQUARE HEAVY FRAMES

CAST IRON

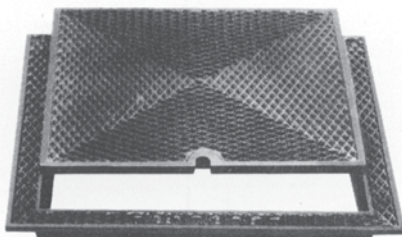

Model No.	Frame Height	Frame Diameter	Standard Package		Part Code Frame
			Quantity	Wt. lbs	
1212-F	1 3/4"	15"x15"	1	16	35-004
1818-F	2"	22"x22"	1	37	35-005
2424-F	2 1/4"	29"x29"	1	61	35-006

SQUARE HEAVY COVERS

Model No.	Cover Diameter	Standard Package		Part Code Solid Cover
		Quantity	Wt. lbs	
1212-S	12"x12"x5/8"	1	13	35-007

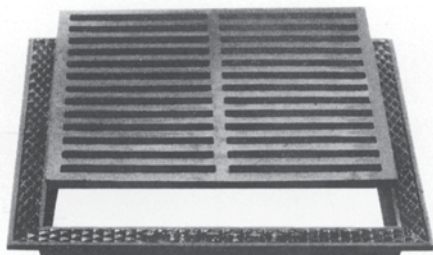

Model No.	Cover Diameter	Standard Package		Part Code Grated Cover
		Quantity	Wt. lbs	
1212-G	12"x12"x5/8"	1	13	35-010
1818-G	18"x18"x5/8"	1	33	35-011
2424-G	24"x24"x5/8"	1	54	35-012

VESTAL MANUFACTURING
Sweetwater, TN 37874
800-456-9562

BELL TRAPS – CAST IRON – LOOSE LID



Model No.	Size	Outlet	Standard Package		Part Code
			Quantity	Wt. lbs	
* 66	6" x 6" x 2"	1 ^{5/8}	12	41	30-001
* 99	9" x 9" x 3"	2 ^{5/8}	6	50	30-002
* 1212	12" x 12" x 4"	3 ^{5/8}	3	60	30-003

*Bell Trap Lids only available

CESSPOOL PLATES – CAST IRON

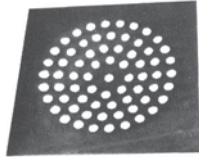

Model No.	Size	Standard Package		Part Code
		Quantity	Wt. lbs	
6	6" x 6"	1	1	30-022
8	8" x 8"	1	3	30-023
10	10" x 10"	1	5	30-024
12	12" x 12"	1	7	30-025

TILE STRAINERS – CAST IRON FOR CLAY PIPE (SUPERIOR)

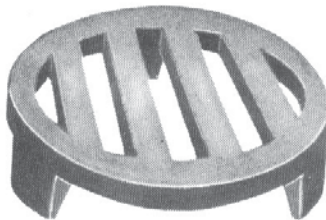

Model No.	For Pipe Size	Overall Diameter	Overall Height	Standard Package		Part Code
				Quantity	Wt. lbs	
4-T	4"	5 ^{5/8}	1½"	6	10	30-007
6-T	6"	8"	2"	6	19	30-008
8-T	8"	10 ¼"	2 ¼"	1	7	30-009
10-T	10"	12 ¼"	2 ¾"	1	8	30-010
12-T	12"	14 ¾"	2 ½"	1	17	30-011
15-T	15"	18 ¾"	2 5/8"	1	35	30-012
18-T	18"	22"	2 ¾"	1	47	30-013

OVERSIZE TILE STRAINERS – CAST IRON FOR CLAY PIPE (LOGAN)



Model No.	For Pipe Size	Overall Diameter	Overall Height	Standard Package		Part Code
				Quantity	Wt. lbs	
Over 6-T	6"	9¼"	2"	1	4	30-031
Over 8-T	8"	11"	2 ¼"	1	8	30-032
Over 10-T	10"	13¼"	2 ¾"	1	10	30-033
Over 12-T	12"	15 ^{7/8} "	2 ½"	1	17	30-034
Over 15-T	15"	19"	2 5/8"	1	37	30-035

TRENCH DRAIN - BOLT DOWN



Model Number	Size	Standard Package		Part Code
		Quantity	Wt. lbs	
V0424	5 ^{3/8} " x 23¼"	1	13	96-769

TRENCH DRAINS HEAVY DUTY CAST IRON

*WILL SUPPORT CAR TRAFFIC



Model Number	Size	Standard Package		Part Code
		Quantity	Wt. lbs	
TD-8*	8" x 24" x 1"	1	33	36-001
TD-12*	12" x 24" x 1"	1	47	36-002
TD-6	6" x 18" x 3/4" (Flat)	1	13	36-003
TD-18	8" x 18" x 3/4" (Flat)	1	15	36-004

RESIDENTIAL AND COMMERCIAL BUILDING PRODUCTS

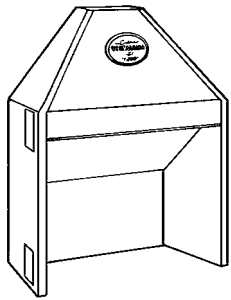

VESTALAIRES

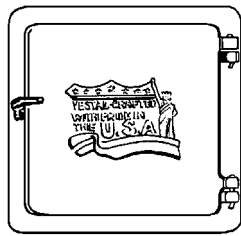

CLEANOUT DOORS



BRICK LINTELS



ANCHOR BOLTS



EXPANDA POSTS

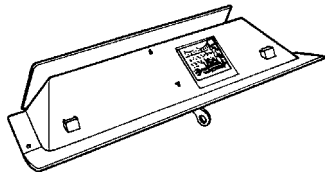

ROTARY OR POKER CONTROL DAMPERS

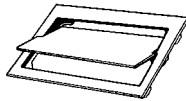

ASH DUMPS

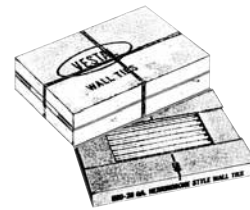

WALL TIES

VESTAL-CRAFTED WITH PRIDE IN THE U.S.A.
Celebrating Over 75 Years of Excellence
 Since 1946

SALES 1-800-456-9562
FAX (423) 337-2003
EMAIL ADDRESS: vestal@vestalmfg.com
WEB PAGE: www.vestalmfg.com



CAST IRON GRATE BASKETS



LOG RESTS



STEEL BAR GRATE BASKETS

FIREPLACE ACCESSORY PRODUCTS

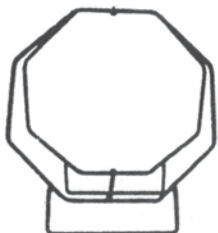

STEEL BAR LOG RACKS

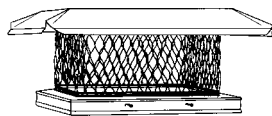

GALVANIZED & STAINLESS CHIMNEY CAPS

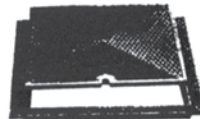

SQUARE FRAME AND COVERS



WATER METER LIDS

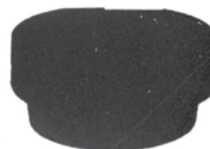

FIXED CAST IRON RISERS



ROUND FRAME AND COVERS



ROUND METER BOX RINGS AND COVERS



EXPANDER RINGS

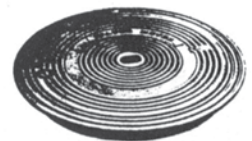

CAST IRON PIT RING AND COVERS

MUNICIPAL AND O.E.M. CAST IRON PRODUCTS