

2026 PRODUCT DATA

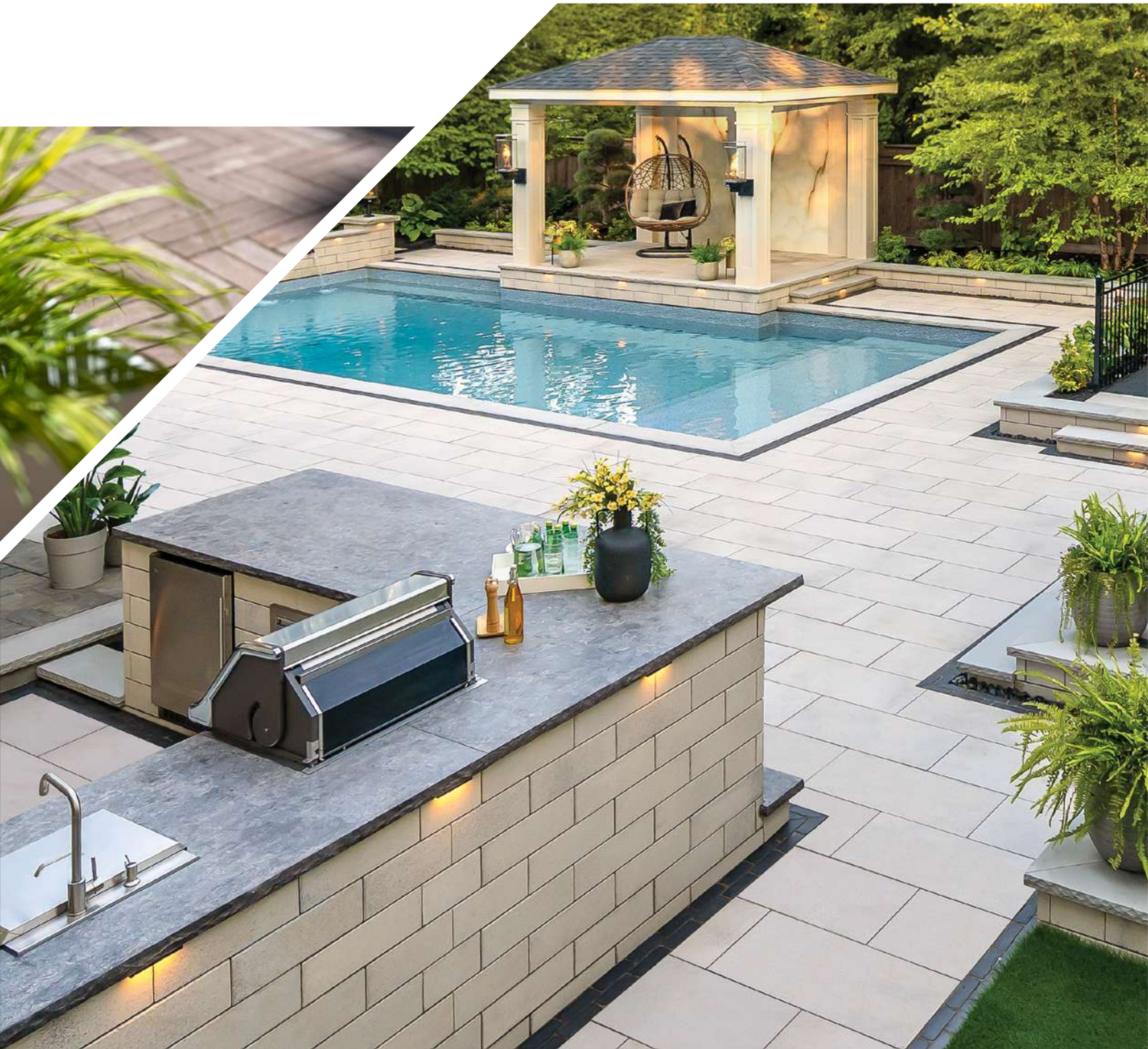

TRANSFORMING
HARDSCAPES



VIEW

AR

LANDSCAPE VISUALIZER

Exclusive to **UNILOCK**

IMPRESS CLIENTS ON THE SPOT

Simply pan the yard using Uview™ and bring your vision to life in real time with pavers, walls, and vertical elements to get homeowners excited about the possibilities.



**DOWNLOAD
NOW**

PART OF A COMPLETE TOOL-KIT

 LEVEL™

 VISION™
3D LANDSCAPE CREATOR

***SPEED-CALC*™**
PAVER AND WALL CALCULATOR

PAVERS

| | | |
|--|-----------------------------------|---------------------------------------|
| 04 ADA Paver | 19 Eco-Optiloc™ | 38 Richcliff® |
| 05 Arcana™ | 20 Eco-Priora™ Premier | 39 Skyline™ |
| 06 Artline™ Premier Finish | 21 Eco-Promenade® Ecoterra | 40 Soreno™ |
| 07 Artline™ Umbriano® Finish | 22 Eco-Promenade® | 41 Town Hall® |
| 08 Beacon Hill™ Flagstone 60mm | 23 Eco-Stone™ | 42 Treo™ Flagstone |
| 09 Beacon Hill™ Flagstone 80mm | 24 Hex™ | 43 Treo™ Smooth |
| 10 Beacon Hill™ Smooth 60mm | 25 Holland Premier™ | 44 Treo™ Smooth with EasyClean |
| 11 Beacon Hill™ Smooth with EasyClean | 26 Il Campo® | 45 Tribeca Cobble™ Series |
| 12 Bristol Valley® | 27 Mattoni™ | 46 Tribeca Cobble™ Premier |
| 13 Brussels Block® | 28 Natural Stone | 47 Turfstone™ |
| 14 Camelot® Premier | 33 Nordic Cobble™ | 48 Umbriano® 50mm Slabs |
| 15 Cophorne® | 34 Optiloc™ | 49 Umbriano® 60mm |
| 16 Courtstone® | 35 Porcelain | 50 Umbriano® 80mm |
| 17 Eco-Hex™ | 36 Promenade™ 100mm | 51 Urban™ |
| 18 Eco-Line® | 37 Promenade™ 70mm | 52 Westport™ |

WALLS

| | | |
|---------------------------------------|---|--|
| 53 Brussels Dimensional Stone® | 61 Pisa™ Edge | 67 U-Cara® Multi-Face Wall System |
| 54 Concord Wall™ | 62 Quarry™ Smooth | 69 U-Cara® Fascia Panels |
| 55 Dura Hold® | 63 Rivercrest® Wall | 71 U-Cara® Backer |
| 57 Dura Hold 2® | 64 Rivercrest® Pillar & Fire Pit | 72 U-Cara® Modular System |
| 58 Estate Wall™ | 65 SienaEdge™ | 73 U-Cara® Wall Mount System |
| 59 Lineo™ Dimensional Stone | 66 SienaStone™ | 74 Universal Base |
| 60 Pisa™ XL Smooth | | |

COPING, STEPS, PILLAR CAPS AND FIRE FEATURES

| |
|---|
| 75 Architectural Coping and Pillar Cap |
| 76 Endura™ Coping |
| 77 Fullnose™ 6 x12 |
| 78 LedgeStone™ |
| 80 Umbriano® Coping |
| 81 Lineo™ Dimensional Fire Pit |
| 82 RomanStack™ Fire Pit Kit |
| 83 Sunset Fire Pit Kit |

ACCESSORIES

| | |
|-----------------------------------|--|
| 84 SkyView™ | 89 Edge Restraints |
| 85 Cleaners | 89 Unilock Drivegrid System™ |
| 85 Sealers | 89 Paver Spacers |
| 85 Paver Edging | 90 Geotextile & Fabric Products |
| 85 Adhesive | 90 PaverSaver Uni Mat |
| 85 Permeable Chip Products | 90 Stainless Steel Fireplace Insert |
| 86 Sands | 91 Tools & Accessories |
| 87 U-Core | 92 Important notes |
| 88 Sealer Best Practices | 93 Terms and Conditions of Sale |
| 88 Polysand Best Practices | |

DESCRIPTION OF PAVER EDGE DETAILS



Zero-Edge



Chamfered Edge



Rounded Bevel



Micro Bevel

ADA Paver



APPLICATIONS

Pedestrian, Light Vehicular, Border/Accents

APPEARANCE

Edge Detail - Chamfer
 Surface Texture - Smooth
 Joint Spacing - 3 mm

DRIVE FRIENDLY

Can handle vehicular loads

TECHNICAL INFORMATION

Conforms to ASTM C936
 Eligible for LEED v4.1 credits

| | |
|----------------|----------|
| | STANDARD |
| Bundle Type | SINGLE |
| Plant Produced | UXBRIDGE |
| Thickness (mm) | 70 mm |

| | | |
|----------|--------|-------|
| SQFT PER | Stone | 1.00 |
| | Layer | 12.00 |
| | Bundle | 96.00 |

| | | |
|------------|--------|---|
| PER BUNDLE | Layers | 8 |
|------------|--------|---|

| | | |
|------------------|--------|-------|
| SOLDIER LNFT PER | SqFt | 1.00 |
| | Layer | 12.00 |
| | Bundle | 96.00 |

| | | |
|-----------------|--------|-------|
| SAILOR LNFT PER | SqFt | 1.00 |
| | Layer | 12.00 |
| | Bundle | 96 |

| | | |
|-----------|--------|------|
| UNITS PER | SqFt | 1.00 |
| | Layer | 12 |
| | Bundle | 96 |

| | | |
|---------|--------|-------|
| LBS PER | Unit | 36 |
| | Layer | 428 |
| | Bundle | 3,442 |

| Colors | Reflectance | Stock |
|---------------|----------------|-------|
| Dark Charcoal | SR n/a SRI n/a | S0 |
| Red | SR .40 SRI 44 | S0 |



DARK CHARCOAL



RED

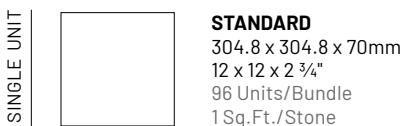
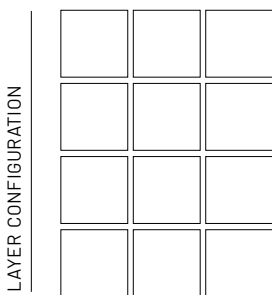

Notes: Special Order. Lead time required. SOLD IN FULL BUNDLES ONLY. All measurements are nominal. Contact Unilock for more information.



APPLICATIONS

Pedestrian, Roof Deck

APPEARANCE

Edge Detail - Micro
Surface Texture - Smooth
Joint Spacing - 0 mm

TECHNICAL INFORMATION

Conforms to ASTM C1782
Eligible for LEED v4.1 credits

// Perfect for roof decks and other raised floor applications.

Ask us about our Skyview™ pedestal system.
See page 84 for more information.

| | | | |
|----------------|---------|---------|---------|
| | 12 x 24 | 18 x 24 | 24 x 24 |
| Bundle Type | SINGLE | SINGLE | SINGLE |
| Plant Produced | CHICAGO | CHICAGO | CHICAGO |
| Thickness (mm) | 50 mm | 50 mm | 50 mm |

| | | | | |
|----------|--------|-------|-------|-------|
| SQFT PER | Stone | 2.00 | 3.00 | 4.00 |
| | Bundle | 36.00 | 54.00 | 72.00 |

| | | | | |
|------------------|--------|-------|-------|-------|
| SOLDIER LNFT PER | SqFt | 0.99 | 0.99 | 0.99 |
| | Bundle | 35.55 | 53.50 | 71.57 |

| | | | | |
|-----------------|--------|-------|-------|-------|
| SAILOR LNFT PER | SqFt | 1.99 | 1.33 | 0.99 |
| | Bundle | 71.57 | 71.57 | 71.57 |

| | | | | |
|-----------|--------|------|------|------|
| UNITS PER | SqFt | 0.50 | 0.33 | 0.25 |
| | Bundle | 18 | 18 | 18 |

| | | | | |
|---------|--------|-----|-------|-------|
| LBS PER | Unit | 48 | 72 | 96 |
| | Bundle | 864 | 1,296 | 1,728 |

| Colors | Reflectance | Stock | Stock | Stock |
|---------|----------------|-------|-------|-------|
| Avorio | SR .56 SRI 66 | ✓ | ✓ | ✓ |
| Corvara | SR .32 SRI 34 | ✓ | ✓ | ✓ |
| Ferrano | SR n/a SRI n/a | ✓ | ✓ | ✓ |
| Modena | SR .46 SRI 53 | ✓ | ✓ | ✓ |
| Vivanto | SR .18 SRI 16 | ✓ | ✓ | ✓ |

SLAB SPACERS

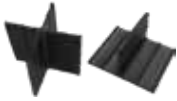

X & T Slab Spacers
Bagged & Sold Separately.

LAYING PATTERNS

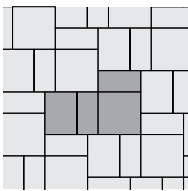

Random A

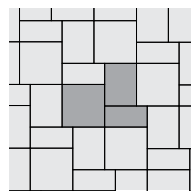

Random C

SINGLE UNITS



12 x 24
301 x 606 x 50mm
11⁷/₈ x 23⁷/₈ x 2"
18 Units/Bundle
2 Sq.Ft./Stone



18 x 24
453 x 606 x 50mm
17⁷/₈ x 23⁷/₈ x 2"
18 Units/Bundle
3 Sq.Ft./Stone



24 x 24
606 x 606 x 50mm
23⁷/₈ x 23⁷/₈ x 2"
18 Units/Bundle
4 Sq.Ft./Stone



AVORIO

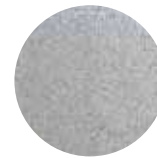

CORVARA



FERRANO
NEW



MODENA



VIVANTO

Notes: LEAD TIME REQUIRED. SOLD IN FULL BUNDLES ONLY and is produced and sold on a required, refundable skid. Unilock offers adjustable and stackable pedestal systems; please contact your Territory Manager for pricing and availability. **Product is not intended for vehicular applications.** All measurements are nominal. Unilock recommends to install Arcana using T and X Slab spacers. Please contact your Territory Manager for more information.



APPLICATIONS

Pedestrian, Light Vehicular

APPEARANCE

Edge Detail - Micro

Surface Texture - Smooth

Joint Spacing - 3 mm

TECHNICAL INFORMATION

Conforms to ASTM C 936

Eligible for LEED v4.1 credits

LAYER CONFIGURATION

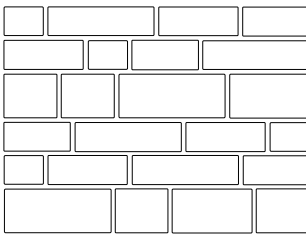

LAYING PATTERNS

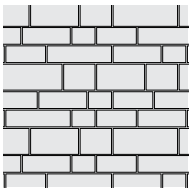

Artline Random A

7 UNIT RANDOM BUNDLE

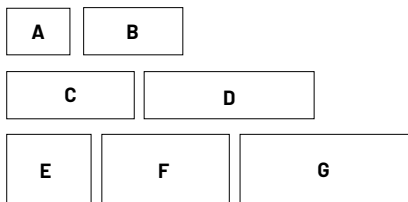

UNIT A
125 x 168.8 x 70mm
4 7/8 x 6 5/8 x 2 3/4"
32 Units/Bundle
.23 Sq.Ft./Stone

UNIT B
125 x 281.3 x 70mm
4 7/8 x 11 1/8 x 2 3/4"
32 Units/Bundle
.38 Sq.Ft./Stone

UNIT C
125 x 337.5 x 70mm
4 7/8 x 13 1/4 x 2 3/4"
32 Units/Bundle
.45 Sq.Ft./Stone

UNIT D
125 x 450 x 70mm
4 7/8 x 17 3/4 x 2 3/4"
32 Units/Bundle
.61 Sq.Ft./Stone

UNIT E
187.5 x 225 x 70mm
7 3/8 x 8 7/8 x 2 3/4"
32 Units/Bundle
.45 Sq.Ft./Stone

UNIT F
187.5 x 337.5 x 70mm
7 3/8 x 13 1/4 x 2 3/4"
16 Units/Bundle
.68 Sq.Ft./Stone

UNIT G
187.5 x 450 x 70mm
7 3/8 x 17 3/4 x 2 3/4"
16 Units/Bundle
.91 Sq.Ft./Stone

| | | MULTIPLE SIZES |
|--|----------------|----------------|
| | Bundle Type | RANDOM |
| | Plant Produced | NEW YORK |
| | Thickness (mm) | 70 mm |

| | | |
|-----------------|--------|-------|
| SQFT PER | Stone | - |
| | Layer | 11.66 |
| | Bundle | 93.25 |

| | | |
|-------------------|--------|---|
| PER BUNDLE | Layers | 8 |
|-------------------|--------|---|

| | | |
|-------------------------|--------|---|
| SOLDIER LNFT PER | SqFt | - |
| | Layer | - |
| | Bundle | - |

| | | |
|------------------------|--------|---|
| SAILOR LNFT PER | SqFt | - |
| | Layer | - |
| | Bundle | - |

| | | |
|------------------|--------|-----|
| UNITS PER | SqFt | - |
| | Layer | 24 |
| | Bundle | 192 |

| | | |
|----------------|--------|-------|
| LBS PER | Unit | - |
| | Layer | 388 |
| | Bundle | 3,100 |

| Colors | Reflectance | Stock |
|----------------|---------------|-------|
| Fossil | SR .22 SRI 21 | ✓ |
| Granite Fusion | SR .30 SRI 32 | ✓ |



FOSSIL



GRANITE FUSION

Notes: SOLD IN FULL BUNDLES ONLY and is produced and sold on a required, refundable skid. Important: A urethane rubber paver mat must be used to prevent scuffing when compacting. All measurements are nominal. Contact Unilock for more information.



APPLICATIONS

Pedestrian, Light Vehicular

APPEARANCE

Edge Detail - Micro

Surface Texture - Umbriano Mottled

Joint Spacing - 3 mm

TECHNICAL INFORMATION

Conforms to ASTM C 936

Eligible for LEED v4.1 credits

LAYER CONFIGURATION

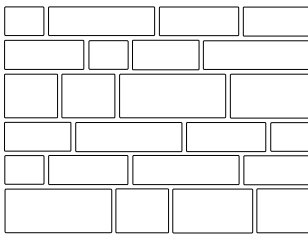

LAYING PATTERNS

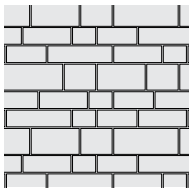

Artline Random A

7 UNIT RANDOM BUNDLE

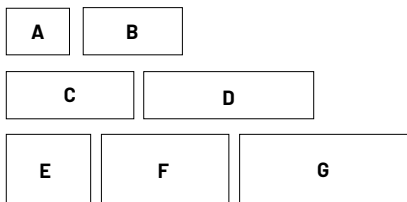

UNIT A

125 x 168.8 x 70mm
4 7/8 x 6 5/8 x 2 3/4"
32 Units/Bundle
.23 Sq.Ft./Stone

UNIT B

125 x 281.3 x 70mm
4 7/8 x 11 1/8 x 2 3/4"
32 Units/Bundle
.38 Sq.Ft./Stone

UNIT C

125 x 337.5 x 70mm
4 7/8 x 13 1/4 x 2 3/4"
32 Units/Bundle
.45 Sq.Ft./Stone

UNIT D

125 x 450 x 70mm
4 7/8 x 17 3/4 x 2 3/4"
32 Units/Bundle
.61 Sq.Ft./Stone

UNIT E

187.5 x 225 x 70mm
7 3/8 x 8 7/8 x 2 3/4"
32 Units/Bundle
.45 Sq.Ft./Stone

UNIT F

187.5 x 337.5 x 70mm
7 3/8 x 13 1/4 x 2 3/4"
16 Units/Bundle
.68 Sq.Ft./Stone

UNIT G

187.5 x 450 x 70mm
7 3/8 x 17 3/4 x 2 3/4"
16 Units/Bundle
.91 Sq.Ft./Stone

| MULTIPLE SIZES | |
|----------------|----------|
| Bundle Type | RANDOM |
| Plant Produced | NEW YORK |
| Thickness (mm) | 70 mm |

| | | |
|----------|--------|-------|
| SQFT PER | Stone | - |
| | Layer | 11.66 |
| | Bundle | 93.25 |

| | | |
|------------|--------|---|
| PER BUNDLE | Layers | 8 |
|------------|--------|---|

| | | |
|------------------|--------|---|
| SOLDIER LNFT PER | SqFt | - |
| | Layer | - |
| | Bundle | - |

| | | |
|-----------------|--------|---|
| SAILOR LNFT PER | SqFt | - |
| | Layer | - |
| | Bundle | - |

| | | |
|-----------|--------|-----|
| UNITS PER | SqFt | - |
| | Layer | 24 |
| | Bundle | 192 |

| | | |
|---------|--------|-------|
| LBS PER | Unit | - |
| | Layer | 414 |
| | Bundle | 3,310 |

| Colors | Reflectance | Stock |
|---------------|---------------|-------|
| French Grey | SR .35 SRI 38 | ✓ |
| Midnight Sky | SR .35 SRI 38 | ✓ |
| Winter Marvel | SR .18 SRI 17 | ✓ |



FRENCH GREY

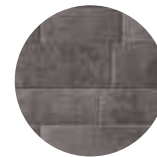

MIDNIGHT SKY



WINTER MARVEL

Notes: SOLD IN FULL BUNDLES ONLY and is produced and sold on a required, refundable skid. Important: A urethane rubber paver mat must be used to prevent scuffing when compacting. All measurements are nominal. Contact Unilock for more information.

Beacon Hill™ Flagstone 60mm



APPLICATIONS

Pedestrian

APPEARANCE

Edge Detail - Rounded

Surface Texture - Textured

Joint Spacing - 7 mm

TECHNICAL INFORMATION

Conforms to ASTM C 936

Eligible for LEED v4.1 credits

| | |
|----------------|---------------------|
| Bundle Type | RANDOM |
| Plant Produced | NEW YORK / UXBRIDGE |
| Thickness (mm) | 60 mm |

| | | |
|----------|--------|--------|
| SQFT PER | Stone | - |
| | Layer | 11.66 |
| | Bundle | 116.57 |

| | | |
|------------|--------|----|
| PER BUNDLE | Layers | 10 |
|------------|--------|----|

| | | |
|------------------|--------|---|
| SOLDIER LNFT PER | SqFt | - |
| | Layer | - |
| | Bundle | - |

| | | |
|-----------------|--------|-------|
| SAILOR LNFT PER | SqFt | 0.80 |
| | Layer | 9.35 |
| | Bundle | 93.50 |

| | | |
|-----------|--------|----|
| UNITS PER | SqFt | - |
| | Layer | 8 |
| | Bundle | 80 |

| | | |
|---------|--------|-------|
| LBS PER | Unit | - |
| | Layer | 328 |
| | Bundle | 3,279 |

| Colors | Reflectance | Stock |
|----------------|----------------|-------|
| Almond Grove | SR .25 SRI 25 | ✓ |
| Fossil | SR .22 SRI 21 | ✓ |
| Granite Fusion | SR .30 SRI 32 | ✓ |
| Sierra | SR n/a SRI n/a | ✓ |
| Tuscany | SR .39 SRI 44 | ✓ |

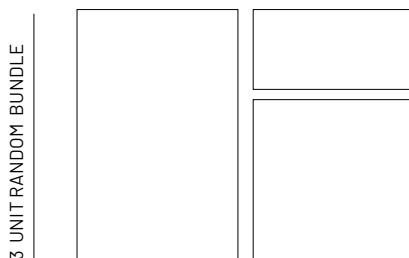
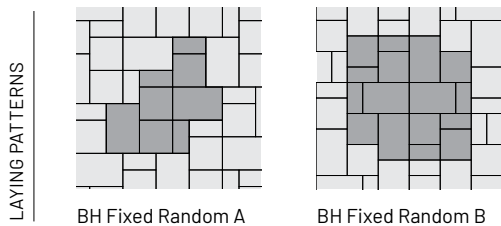
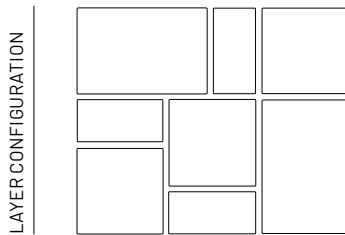

LARGE RECTANGLE
 380 x 570 x 60mm
 15 x 22 1/2 x 2 3/8"
 20 Units/Bundle
 2.33 SqFt/Stone

SQUARE
 380 x 380 x 60mm
 15 x 15 x 2 3/8"
 30 Units/Bundle
 1.55 Sq.Ft./Stone

SMALL RECTANGLE
 380 x 190 x 60mm
 15 x 7 1/2 x 2 3/8"
 30 Units/Bundle
 .78 Sq.Ft./Stone



Notes: **SOLD IN FULL BUNDLES ONLY** and is produced and sold on a required, refundable skid. This product is not intended for vehicular applications. **Important: A urethane rubber paver mat must be used to prevent scuffing when compacting.**
 All measurements are nominal. Contact Unilock for more information.

Beacon Hill™ Flagstone 80mm



APPLICATIONS

Pedestrian, Light Vehicular

APPEARANCE

Edge Detail - Rounded

Surface Texture - Textured

Joint Spacing - 4 mm

TECHNICAL INFORMATION

Conforms to ASTM C 936

Eligible for LEED v4.1 credits

| | |
|----------------|----------|
| Bundle Type | RANDOM |
| Plant Produced | UXBRIDGE |
| Thickness (mm) | 80 mm |

| | | |
|----------|--------|-------|
| SQFT PER | Stone | - |
| | Layer | 11.66 |
| | Bundle | 81.60 |

| | | |
|------------|--------|---|
| PER BUNDLE | Layers | 7 |
|------------|--------|---|

| | | |
|------------------|--------|---|
| SOLDIER LNFT PER | SqFt | - |
| | Layer | - |
| | Bundle | - |

| | | |
|-----------------|--------|-------|
| SAILOR LNFT PER | SqFt | 0.80 |
| | Layer | 9.35 |
| | Bundle | 65.45 |

| | | |
|-----------|--------|----|
| UNITS PER | SqFt | - |
| | Layer | 8 |
| | Bundle | 56 |

| | | |
|---------|--------|-------|
| LBS PER | Unit | - |
| | Layer | 427 |
| | Bundle | 2,988 |

| Colors | Reflectance | Stock |
|----------------|---------------|-------|
| Fossil | SR .22 SRI 21 | ✓ |
| Granite Fusion | SR .30 SRI 32 | ✓ |

LAYER CONFIGURATION

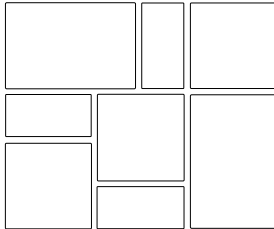

LAYING PATTERNS

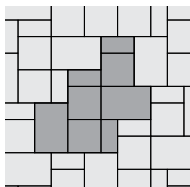

BH Fixed Random A

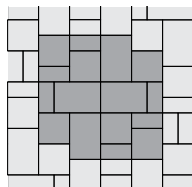

BH Fixed Random B

3 UNIT RANDOM BUNDLE

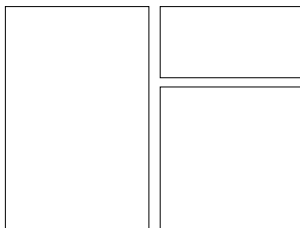

LARGE RECTANGLE

380 x 570 x 80mm
15 1/2 x 22 1/2 x 3 1/8"
14 Units/Bundle
2.33 SqFt./Stone

SQUARE

380 x 380 x 80mm
15 x 15 x 3 1/8"
21 Units/Bundle
1.55 Sq.Ft./Stone

SMALL RECTANGLE

380 x 190 x 80mm
15 x 7 1/2 x 3 1/8"
21 Units/Bundle
.78 Sq.Ft./Stone



FOSSIL

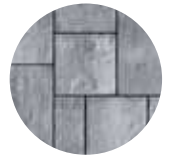

GRANITE FUSION

Notes: SOLD IN FULL BUNDLES ONLY and is produced and sold on a required, refundable skid. Important: A urethane rubber paver mat must be used to prevent scuffing when compacting. All measurements are nominal. Contact Unilock for more information.

Beacon Hill™ Smooth 60mm



APPLICATIONS

Pedestrian, Roof Deck

APPEARANCE

Edge Detail - Rounded; Surface Texture Smooth;
Joint Spacing - 4 mm

TECHNICAL INFORMATION

Conforms to ASTM C 936
Eligible for LEED v4.1 credits

| | | | | |
|----------------|-------------------|----------|--------|-------------------|
| | | | XL | SMALL RECTANGLE |
| Bundle Type | RANDOM | | SINGLE | SINGLE |
| Plant Produced | NEW YORK UXBRIDGE | UXBRIDGE | | NEW YORK UXBRIDGE |
| Thickness (mm) | 60 mm | 60 mm | | 60 mm |

| | | | | |
|----------|--------|--------|-------|--------|
| SQFT PER | Stone | - | 5.83 | 0.78 |
| | Layer | 11.66 | 11.66 | 11.66 |
| | Bundle | 116.57 | 81.59 | 116.57 |

| | | | | |
|------------|--------|----|---|----|
| PER BUNDLE | Layers | 10 | 7 | 10 |
|------------|--------|----|---|----|

| | | | | |
|------------------|--------|---|-------|-------|
| SOLDIER LNFT PER | SqFt | - | 0.32 | 0.80 |
| | Layer | - | 3.74 | 9.35 |
| | Bundle | - | 26.18 | 93.50 |

| | | | | |
|-----------------|--------|-------|-------|--------|
| SAILOR LNFT PER | SqFt | 0.80 | 0.53 | 1.60 |
| | Layer | 9.35 | 6.23 | 18.70 |
| | Bundle | 93.50 | 43.61 | 187.01 |

| | | | | |
|-----------|--------|------|------|------|
| UNITS PER | SqFt | 0.69 | 0.17 | 1.29 |
| | Layer | 8 | 2 | 15 |
| | Bundle | 80 | 14 | 150 |

| | | | | |
|---------|--------|-------|-------|-------|
| LBS PER | Unit | - | 160 | 22 |
| | Layer | 336 | 320 | 332 |
| | Bundle | 3,360 | 2,240 | 3,318 |

| Colors | Reflectance | Stock | Stock | Stock |
|----------------|----------------|-------|-------|-------|
| Almond Grove | SR .25 SRI 25 | ✓ | - | ✓ |
| Fossil | SR .22 SRI 21 | ✓ | ✓ | ✓ |
| Granite Fusion | SR .30 SRI 32 | ✓ | ✓ | ✓ |
| Platinum | SR n/a SRI n/a | ✓ | ✓ | ✓ |
| Dark Charcoal | SR n/a SRI n/a | - | - | ✓ |

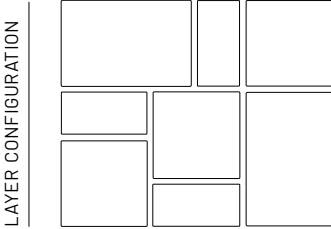

XL UNIT
950 x 570 x 60mm
37½ x 22½ x 2 ¾"
14 Units/Bundle
5.83 Sq.Ft./Stone

SMALL RECTANGLE
380 x 190 x 60mm
15 x 7½ x 2 ¾"
150 Units/Bundle
.78 Sq.Ft./Stone

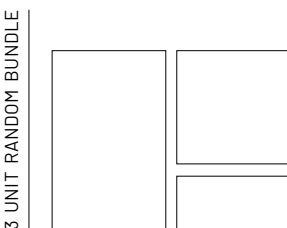

LARGE RECTANGLE
380 x 570 x 60mm
15 x 22 ½ x 2 ¾"
20 Units/Bundle
2.33 SqFt./Stone

SQUARE
380 x 380 x 60mm
15 x 15 x 2 ¾"
30 Units/Bundle
1.55 Sq.Ft./Stone

SMALL RECTANGLE
380 x 190 x 60mm
15 x 7½ x 2 ¾"
30 Units/Bundle
.78 Sq.Ft./Stone



ALMOND GROVE

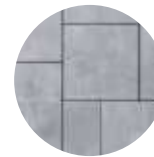

PLATINUM



FOSSIL

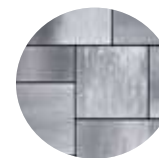

GRANITE FUSION



DARK CHARCOAL
(Small Rec Only)

Notes: SOLD IN FULL BUNDLES ONLY and is produced and sold on a required, refundable skid. This product is not intended for vehicular applications. **Important: A urethane rubber paver mat must be used to prevent scuffing when compacting.**
All measurements are nominal. Contact Unilock for more information.



APPLICATIONS

Pedestrian, Roof Deck

APPEARANCE

Edge Detail - Rounded

Surface Texture - Smooth

Joint Spacing - 4 mm

TECHNICAL INFORMATION

Conforms to ASTM C 936

Eligible for LEED v4.1 credits

| Bundle Type | RANDOM | SMALL RECTANGLE |
|----------------|----------|-----------------|
| Plant Produced | UXBRIDGE | UXBRIDGE |
| Thickness (mm) | 60 mm | 60 mm |

| SQFT PER | Stone | - | 0.78 |
|----------|--------|--------|--------|
| | Layer | 11.66 | 11.66 |
| | Bundle | 116.57 | 116.57 |

| PER BUNDLE | Layers | 10 | 10 |
|------------|--------|----|----|
|------------|--------|----|----|

| SOLDIER LNFT PER | SqFt | - | 0.80 |
|------------------|--------|---|-------|
| | Layer | - | 9.35 |
| | Bundle | - | 93.50 |

| SAILOR LNFT PER | SqFt | 0.80 | 1.60 |
|-----------------|--------|-------|--------|
| | Layer | 9.35 | 18.70 |
| | Bundle | 93.50 | 187.01 |

| UNITS PER | SqFt | - | 1.29 |
|-----------|--------|----|------|
| | Layer | 8 | 15 |
| | Bundle | 80 | 150 |

| LBS PER | Unit | - | 22 |
|---------|--------|-------|-------|
| | Layer | 328 | 332 |
| | Bundle | 3,279 | 3,318 |

| Colors | Reflectance | Stock | Stock |
|----------------|----------------|-------|-------|
| Almond Grove | SR .25 SRI 25 | ✓ | ✓ |
| Fossil | SR .22 SRI 21 | ✓ | ✓ |
| Granite Fusion | SR .30 SRI 32 | ✓ | ✓ |
| Oat Beige | SR .49 SRI 57 | ✓ | ✓ |
| Platinum | SR n/a SRI n/a | ✓ | ✓ |
| Dark Charcoal | SR n/a SRI n/a | - | ✓ |

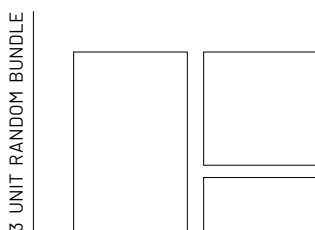
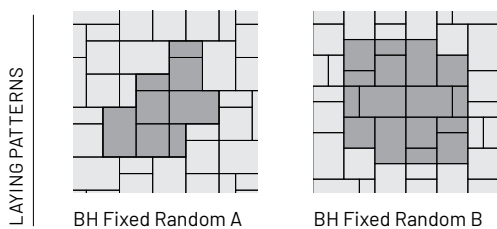
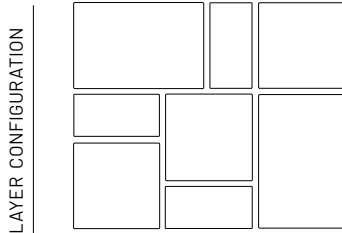

LARGE RECTANGLE
380 x 570 x 60mm
15 x 22 1/2 x 2 3/8"
20 Units/Bundle
2.33 SqFt./Stone

SQUARE
380 x 380 x 60mm
15 x 15 x 2 3/8"
30 Units/Bundle
1.55 Sq.Ft./Stone

SMALL RECTANGLE
380 x 190 x 60mm
15 x 7 1/2 x 2 3/8"
30 Units/Bundle
.78 Sq.Ft./Stone

SINGLE UNIT

SMALL RECTANGLE
380 x 190 x 60mm
15 x 7 1/2 x 2 3/8"
150 Units/Bundle
.78 Sq.Ft./Stone



Notes: SOLD IN FULL BUNDLES ONLY and is produced and sold on a required, refundable skid. This product is not intended for vehicular applications. **Important: A urethane rubber paver mat must be used to prevent scuffing when compacting.** All measurements are nominal. Contact Unilock for more information.



APPLICATIONS

Pedestrian

APPEARANCE

Edge Detail - Zero

Surface Texture - Textured

Joint Spacing - 7 mm

TECHNICAL INFORMATION

Conforms to ASTM C 936

Eligible for LEED v4.1 credits

| | |
|----------------|----------|
| Bundle Type | RANDOM |
| Plant Produced | UXBRIDGE |
| Thickness (mm) | 60 mm |

| | | |
|----------|--------|--------|
| SQFT PER | Stone | - |
| | Layer | 11.66 |
| | Bundle | 116.57 |

| | | |
|------------|--------|----|
| PER BUNDLE | Layers | 10 |
|------------|--------|----|

| | | |
|------------------|--------|---|
| SOLDIER LNFT PER | SqFt | - |
| | Layer | - |
| | Bundle | - |

| | | |
|-----------------|--------|-------|
| SAILOR LNFT PER | SqFt | 0.80 |
| | Layer | 9.35 |
| | Bundle | 93.50 |

| | | |
|-----------|--------|----|
| UNITS PER | SqFt | - |
| | Layer | 8 |
| | Bundle | 80 |

| | | |
|---------|--------|-------|
| LBS PER | Unit | - |
| | Layer | 330 |
| | Bundle | 3,295 |

| Colors | Reflectance | Stock |
|----------------|----------------|-------|
| Fossil | SR .22 SRI 21 | ✓ |
| Steel Mountain | SR .30 SRI 32 | ✓ |
| Walnut | SR n/a SRI n/a | ✓ |

LAYER CONFIGURATION

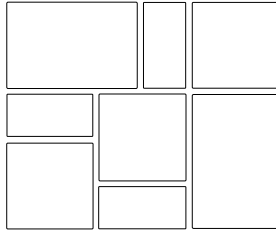

LAYING PATTERNS

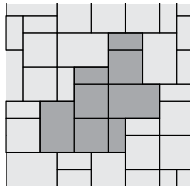

BV Fixed Random A

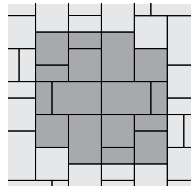

BV Fixed Random B

3 UNIT - RANDOM BUNDLE

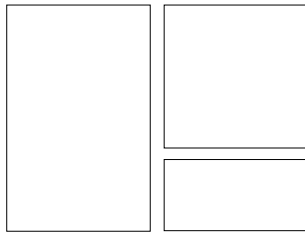

LARGE RECTANGLE

380 x 570 x 60mm
15 x 22 1/2 x 2 3/8"
20 Units/Bundle
2.33 SqFt./Stone

SQUARE

380 x 380 x 60mm
15 x 15 x 2 3/8"
30 Units/Bundle
1.55 Sq.Ft./Stone

SMALL RECTANGLE

380 x 190 x 60mm
15 x 7 1/2 x 2 3/8"
30 Units/Bundle
.78 Sq.Ft./Stone



FOSSIL

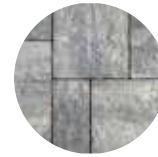

STEEL MOUNTAIN

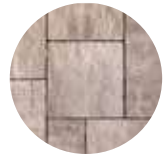

WALNUT

Notes: **SOLD IN FULL BUNDLES ONLY** and is produced and sold on a required, refundable skid. This product is not intended for vehicular applications. **Important: A urethane rubber paver mat must be used to prevent scuffing when compacting.** All measurements are nominal. Contact Unilock for more information.

Brussels Block®



APPLICATIONS

Pedestrian, Light Vehicular, Border and Accents

APPEARANCE

Edge Detail - Zero

Surface Texture - Weathered

Joint Spacing - 2 mm

TECHNICAL INFORMATION

Conforms to ASTM C 936

Eligible for LEED v4.1 credits

LAYER CONFIGURATION

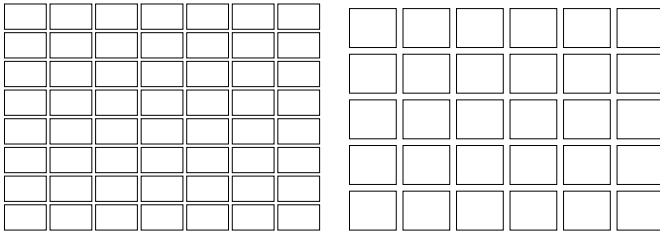

LAYING PATTERNS

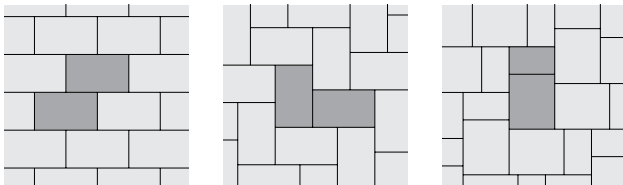

Brussels Halfstone
RB_D

Brussels Halfstone
HB_E

Brussels Multi-Unit
Random_P

SINGLE UNITS

HALF

104 x 173 x 70mm
4 x 6 7/8 x 2 3/4"
448 Units/Bundle
.20 Sq.Ft./Stone



STANDARD

173 x 208 x 70mm
6 7/8 x 8 1/4 x 2 3/4"
224 Units/Bundle
.40 Sq.Ft./Stone



| | HALF | STANDARD |
|----------------|----------|----------|
| Bundle Type | SINGLE | SINGLE |
| Plant Produced | UXBRIDGE | UXBRIDGE |
| Thickness (mm) | 70 mm | 70 mm |

| SQFT PER | Stone | 0.20 | 0.40 |
|----------|--------|-------|-------|
| | Layer | 11.09 | 11.08 |
| | Bundle | 88.70 | 88.60 |

| PER BUNDLE | Layers | 8 | 8 |
|------------|--------|---|---|
|------------|--------|---|---|

| SOLDIER LNFT PER | SqFt | 1.72 | 1.44 |
|------------------|--------|--------|--------|
| | Layer | 19.11 | 15.98 |
| | Bundle | 152.86 | 127.87 |

| SAILOR LNFT PER | SqFt | 2.87 | 1.73 |
|-----------------|--------|--------|--------|
| | Layer | 31.78 | 19.11 |
| | Bundle | 254.28 | 152.86 |

| UNITS PER | SqFt | 5.05 | 2.53 |
|-----------|--------|------|------|
| | Layer | 56 | 28 |
| | Bundle | 448 | 224 |

| LBS PER | Unit | 6 | 12 |
|---------|--------|-------|-------|
| | Layer | 349 | 349 |
| | Bundle | 2,789 | 2,788 |

| Colors | Reflectance | Stock | Stock |
|-----------|----------------|-------|-------|
| Limestone | SR n/a SRI n/a | ✓ | ✓ |
| Sandstone | SR .28 SRI 29 | ✓ | ✓ |
| Sierra | SR n/a SRI n/a | ✓ | ✓ |



LIMESTONE



SANDSTONE



SIERRA

Notes: SOLD IN FULL BUNDLES ONLY. All measurements are nominal. Contact Unilock for more information.



APPLICATIONS

Pedestrian, Light Vehicular, Border and Accents

APPEARANCE

Edge Detail - Rounded Bevel

Surface Texture - Smooth

Joint Spacing - 3 mm

TECHNICAL INFORMATION

Conforms to ASTM C 936

Eligible for LEED v4.1 credits

| | SQUARE | RECTANGLE |
|----------------|----------|-----------|
| Bundle Type | SINGLE | SINGLE |
| Plant Produced | NEW YORK | NEW YORK |
| Thickness (mm) | 60 mm | 60 mm |

| SQFT PER | Stone | 0.28 | 0.41 |
|----------|--------|--------|--------|
| | Layer | 11.55 | 12.37 |
| | Bundle | 115.50 | 123.70 |

| PER BUNDLE | Layers | 10 | 10 |
|------------|--------|----|----|
|------------|--------|----|----|

| SOLDIER LNFT PER | SqFt | 1.91 | 1.27 |
|------------------|--------|--------|--------|
| | Layer | 22.02 | 15.75 |
| | Bundle | 220.20 | 157.48 |

| SAILOR LNFT PER | SqFt | 1.91 | 1.91 |
|-----------------|--------|--------|--------|
| | Layer | 22.02 | 23.62 |
| | Bundle | 220.20 | 236.22 |

| UNITS PER | SqFt | 3.64 | 2.43 |
|-----------|--------|------|------|
| | Layer | 42 | 30 |
| | Bundle | 420 | 300 |

| LBS PER | Unit | 8 | 12 |
|---------|--------|-------|-------|
| | Layer | 323 | 346 |
| | Bundle | 3,233 | 3,464 |

| Colors | Reflectance | Stock | Stock |
|----------------|----------------|-------|-------|
| Almond Grove | SR n/a SRI n/a | ✓ | ✓ |
| Fossil | SR n/a SRI n/a | ✓ | ✓ |
| Granite Fusion | SR .26 SRI 27 | ✓ | ✓ |
| Brown | SR n/a SRI n/a | - | ✓ |
| Dark Charcoal | SR n/a SRI n/a | - | ✓ |

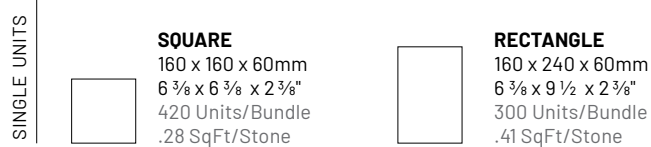
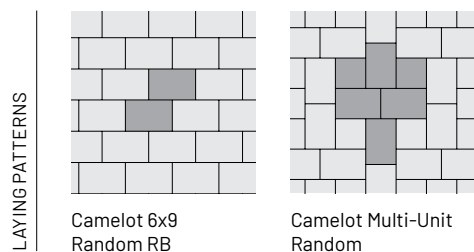
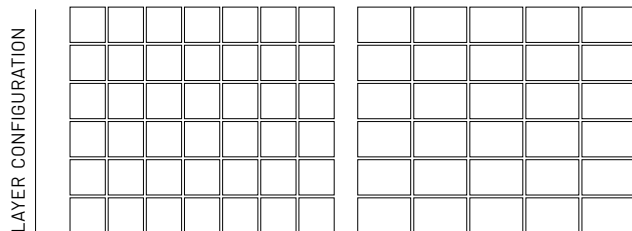

Notes: SOLD IN FULL BUNDLES ONLY and is produced and sold on a required, refundable skid. **Important: A urethane rubber paver mat must be used to prevent scuffing when compacting.** All measurements are nominal. Contact Unilock for more information.



APPLICATIONS

Pedestrian, Light Vehicular, Border/Accents

APPEARANCE

Edge Detail - Rounded

Surface Texture - Textured

Joint Spacing - 3 mm

TECHNICAL INFORMATION

Conforms to ASTM C 936

Eligible for LEED v4.1 credits

| | | |
|------------------|--------|--------|
| Bundle Type | | SINGLE |
| Plant Produced | | AYR |
| Thickness (mm) | | 60 mm |
| SQFT PER | Stone | 0.15 |
| | Layer | 11.15 |
| | Bundle | 89.20 |
| PER BUNDLE | Layers | 8 |
| SOLDIER LNFT PER | SqFt | 1.43 |
| | Layer | 15.99 |
| | Bundle | 127.95 |
| SAILOR LNFT PER | SqFt | 4.41 |
| | Layer | 49.21 |
| | Bundle | 393.70 |
| UNITS PER | SqFt | 6.73 |
| | Layer | 75 |
| | Bundle | 600 |
| LBS PER | Unit | 4 |
| | Layer | 294 |
| | Bundle | 2,349 |

| Colors | Reflectance | Stock |
|--------------|----------------|-------|
| Basalt | SR n/a SRI n/a | ✓ |
| Burgundy Red | SR .35 SRI 38 | ✓ |
| Burnt Clay | SR .36 SRI 40 | ✓ |
| Old Oak | SR .37 SRI 41 | ✓ |
| Arctic Grey | SR .49 SRI 57 | ✓ |
| Steel Blue | SR n/a SRI n/a | ✓ |

LAYING PATTERNS

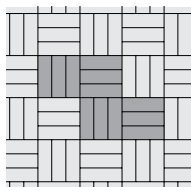

Copthorne BW

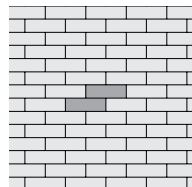

Copthorne RB

SINGLE UNIT



STANDARD

65 x 200 x 60mm
2 5/8 x 7 7/8 x 2 3/8"
600 Units/Bundle
.15 SqFt/Stone



OLD OAK



BURGUNDY RED



BURNT CLAY



3 COLOR BLEND
Blended on Site



ARCTIC GREY



STEEL BLUE



BASALT



3 COLOR GREY BLEND
Blended on Site

Notes: SOLD IN FULL BUNDLES ONLY and is produced and sold on a required, refundable skid. **Important: A urethane rubber paver mat must be used to prevent scuffing when compacting.** All measurements are nominal. Please refer to the Polymeric Sand Best Practices on Page 88. Contact Unilock for more information.



APPLICATIONS

Pedestrian, Light Vehicular, Border/Accents

APPEARANCE

Edge Detail - Rounded
 Surface Texture - Textured
 Joint Spacing - 15 mm

TECHNICAL INFORMATION

Conforms to ASTM C 936
 Eligible for LEED v4.1 credits

| Bundle Type | | RANDOM |
|------------------|--------|--------|
| Plant Produced | | AYR |
| Thickness (mm) | | 60 mm |
| SQFT PER | Stone | - |
| | Layer | 12.29 |
| | Bundle | 98.30 |
| PER BUNDLE | Layers | 8 |
| SOLDIER LNFT PER | SqFt | - |
| | Layer | - |
| | Bundle | - |
| SAILOR LNFT PER | SqFt | 2.25 |
| | Layer | 27.69 |
| | Bundle | 221.52 |
| UNITS PER | SqFt | - |
| | Layer | 48 |
| | Bundle | 384 |
| LBS PER | Unit | - |
| | Layer | 291 |
| | Bundle | 2,326 |

| Colors | Reflectance | Stock |
|--------------|----------------|-------|
| Basalt | SR n/a SRI n/a | ✓ |
| Belgian Blue | SR n/a SRI n/a | ✓ |
| Dawn Mist | SR n/a SRI n/a | ✓ |
| Pebble Taupe | SR n/a SRI n/a | ✓ |

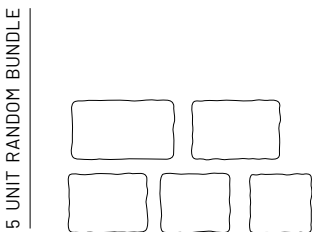
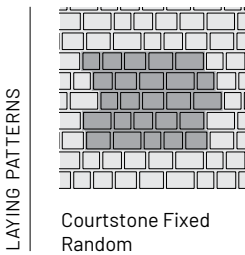

XL RECTANGLE
 215 x 130 x 60mm
 8 3/8 x 5 1/8 x 2 3/8"
 128 Units/Bundle
 .30 SqFt/Stone

LARGE RECTANGLE
 185 x 130 x 60mm
 7 1/4 x 5 1/8 x 2 3/8"
 64 Units/Bundle
 .28 SqFt/Stone

RECTANGLE
 165 x 130 x 60mm
 6 1/2 x 5 1/8 x 2 3/8"
 64 Units/Bundle
 .23 SqFt/Stone

SQUARE
 130 x 130 x 60mm
 5 1/8 x 5 1/8 x 2 3/8"
 64 Units/Bundle
 .18 SqFt/Stone

SMALL RECTANGLE
 145 x 130 x 60mm
 5 3/4 x 5 1/8 x 2 3/8"
 64 Units/Bundle
 .20 SqFt/Stone



Notes: SOLD IN FULL BUNDLES ONLY and is produced and sold on a required, refundable skid. Important: A urethane rubber paver mat must be used to prevent scuffing when compacting. All measurements are nominal. Please refer to the Polymeric Sand Best Practices on Page 88. Contact Unilock for more information.



APPLICATIONS

Pedestrian, Light Vehicular , Permeable

APPEARANCE

Edge Detail Umbriano - Rounded

Surface Texture - Mottled

Joint Spacing - 10 mm

TECHNICAL INFORMATION

Conforms to ASTM C 936

Eligible for LEED v4.1

| | | |
|------------------------------|--------------------|--------------|
| Bundle Type | | SINGLE |
| Plant Produced | | NEW YORK |
| Thickness (mm) | | 80 mm |
| SQFT PER | Stone | 0.39 |
| | Layer | 7.70 |
| | Bundle | 53.89 |
| PER BUNDLE | Layers | 7 |
| SOLDIER LNFT PER | SqFt | - |
| | Layer | - |
| | Bundle | - |
| SAILOR LNFT PER | SqFt | - |
| | Layer | - |
| | Bundle | - |
| UNITS PER | SqFt | 2.60 |
| | Layer | 20 |
| | Bundle | 140 |
| LBS PER | Unit | 14 |
| | Layer | 282 |
| | Bundle | 1,972 |
| Colors | Reflectance | Stock |
| Multiple Colors and Finishes | N/A | SO |

LAYER CONFIGURATION

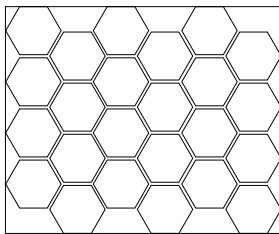

LAYING PATTERNS

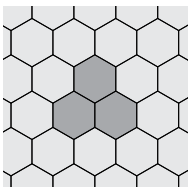

Hex Paver

SINGLE UNIT

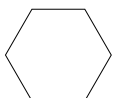

ECO-HEX
 200 x 200 x 80mm
 7 7/8 x 7 7/8 x 3 1/8"
 140 Units/Bundle
 .39 SqFt/Stone



Notes: **Made-to-Order. Minimum quantities apply. SOLD IN FULL BUNDLES ONLY** and is produced and sold on a required, refundable skid. **Important: A urethane rubber paver mat must be used to prevent scuffing when compacting.** All measurements are nominal. Contact Unilock for more information.



APPLICATIONS

Pedestrian, Light Vehicular, Roadway Street,
Heavy-duty, Permeable

APPEARANCE

Edge Detail - Micro
Surface Texture - Smooth / Exposed / Brushed / Umbriano Mottled
Joint Spacing - 6.25 mm

TECHNICAL INFORMATION

Conforms to ASTM C 936
Eligible for LEED v4.1 credits

LAYER CONFIGURATION

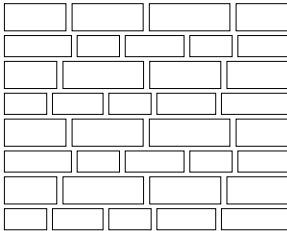

LAYING PATTERNS

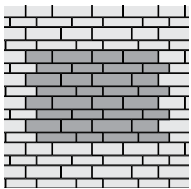

Ecoline Fixed Random

8 UNIT RANDOM BUNDLE

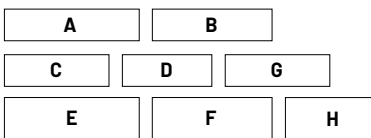

UNIT A

357 x 84 x 100mm
14 x 3 3/16 x 3 7/8"
24 Units/Bundle
.32 SqFt/Stone

UNIT B

317 x 84 x 100mm
12 1/2 x 3 3/16 x 3 7/8"
24 Units/Bundle
.29 SqFt/Stone

UNIT C

277 x 84 x 100mm
12 x 3 3/16 x 3 7/8"
24 Units/Bundle
.25 SqFt/Stone

UNIT D

237 x 84 x 100mm
9 3/8 x 3 3/16 x 3 7/8"
24 Units/Bundle
.21 SqFt/Stone

UNIT E

357 x 114 x 100mm
14 x 4 1/2 x 3 7/8"
24 Units/Bundle
.44 SqFt/Stone

UNIT F

317 x 114 x 100mm
12 1/2 x 4 1/2 x 3 7/8"
24 Units/Bundle
.39 SqFt/Stone

UNIT G

277 x 84 x 100mm
11 x 4 1/2 x 3 7/8"
24 Units/Bundle
.34 SqFt/Stone

UNIT H

237 x 114 x 100mm
9 3/8 x 4 1/2 x 3 7/8"
48 Units/Bundle
.29 SqFt/Stone

| | |
|----------------|----------------|
| | MULTIPLE SIZES |
| Bundle Type | RANDOM |
| Plant Produced | NEW YORK |
| Thickness (mm) | 100 mm |

| | | |
|----------|--------|-------|
| SQFT PER | Stone | - |
| | Layer | 11.03 |
| | Bundle | 66.20 |

| | | |
|------------|--------|---|
| PER BUNDLE | Layers | 6 |
|------------|--------|---|

| | | |
|------------------|--------|---|
| SOLDIER LNFT PER | SqFt | - |
| | Layer | - |
| | Bundle | - |

| | | |
|-----------------|--------|---|
| SAILOR LNFT PER | SqFt | - |
| | Layer | - |
| | Bundle | - |

| | | |
|-----------|--------|-----|
| UNITS PER | SqFt | - |
| | Layer | 36 |
| | Bundle | 216 |

| | | |
|---------|--------|-------|
| LBS PER | Unit | - |
| | Layer | 504 |
| | Bundle | 3,027 |

| Colors | Reflectance | Stock |
|------------------------------|----------------|-------|
| Multiple Colors and Finishes | SR n/a SRI n/a | SO |

Notes: Made-to-Order. Minimum quantities apply. Lead time required. SOLD IN FULL BUNDLES ONLY and is produced and sold on a required, refundable skid. Important: A urethane rubber paver mat must be used to prevent scuffing when compacting on textured surfaces. All measurements are nominal. Contact Unilock for more information.



APPLICATIONS

Pedestrian, Light Vehicular, Roadway Street, Heavy-duty, Permeable

APPEARANCE

Edge Detail - Chamfer
 Surface Texture - Smooth
 Joint Spacing - 12 mm

TECHNICAL INFORMATION

Conforms to ASTM C 936
 Eligible for LEED v4.1 credits

| | | |
|------------------------------|----------------|---------------------|
| | | STANDARD |
| Bundle Type | | SINGLE |
| Plant Produced | | NEW YORK / UXBRIDGE |
| Thickness (mm) | | 80 mm |
| SQFT PER | Stone | 0.50 |
| | Layer | 9.08 |
| | Bundle | 63.56 |
| PER BUNDLE | Layers | 7 |
| SOLDIER LNFT PER | SqFt | - |
| | Layer | - |
| | Bundle | - |
| SAILOR LNFT PER | SqFt | - |
| | Layer | - |
| | Bundle | - |
| UNITS PER | SqFt | 1.98 |
| | Layer | 18 |
| | Bundle | 126 |
| LBS PER | Unit | 16 |
| | Layer | 292 |
| | Bundle | 2,047 |
| Colors | Reflectance | Stock |
| Multiple Colors and Finishes | SR n/a SRI n/a | SO |

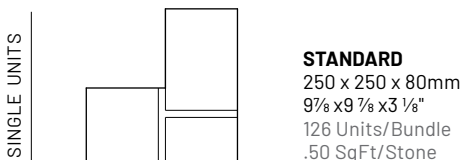
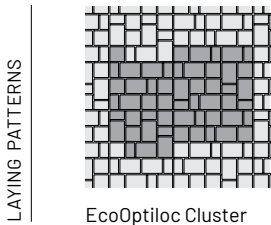
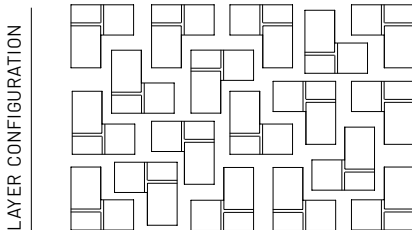

Notes: **Made-to-Order.** Minimum quantities apply. **Lead time required.** **SOLD IN FULL BUNDLES ONLY** and is produced and sold on a required, refundable skid. **Important: A urethane rubber paver mat must be used to prevent scuffing when compacting on textured surfaces.** All measurements are nominal. Contact Unilock for more information.



APPLICATIONS

Pedestrian, Light Vehicular, Roadway Street,
Heavy-duty, Permeable

APPEARANCE

Edge Detail - Micro
Surface Texture - Smooth
Joint Spacing - 7 mm

TECHNICAL INFORMATION

Conforms to ASTM C 936
Eligible for LEED v4.1 credits

| | |
|----------------|----------|
| | 5 x 10 |
| Bundle Type | SINGLE |
| Plant Produced | NEW YORK |
| Thickness (mm) | 80 mm |

| | | |
|----------|--------|-------|
| SQFT PER | Stone | 0.31 |
| | Layer | 10.85 |
| | Bundle | 75.95 |

| | | |
|------------|--------|---|
| PER BUNDLE | Layers | 7 |
|------------|--------|---|

| | | |
|------------------|--------|-------|
| SOLDIER LNFT PER | SqFt | 1.27 |
| | Layer | 13.78 |
| | Bundle | 96.46 |

| | | |
|-----------------|--------|--------|
| SAILOR LNFT PER | SqFt | 2.54 |
| | Layer | 27.56 |
| | Bundle | 192.91 |

| | | |
|-----------|--------|------|
| UNITS PER | SqFt | 3.23 |
| | Layer | 35 |
| | Bundle | 245 |

| | | |
|---------|--------|-------|
| LBS PER | Unit | 11 |
| | Layer | 388 |
| | Bundle | 2,717 |

| Colors | Reflectance | Stock |
|----------------|----------------|-------|
| Granite Fusion | SR n/a SRI n/a | ✓ |
| Steel Grey | SR n/a SRI n/a | ✓ |
| Opal Blend | SR n/a SRI n/a | ✓ |

LAYER CONFIGURATION

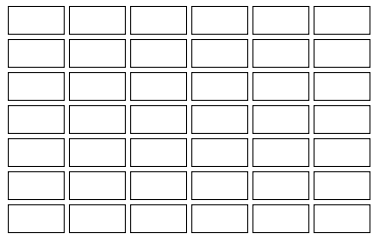

LAYING PATTERNS

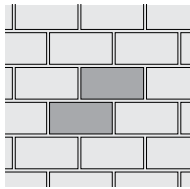

Eco-Priora 5x10 RB

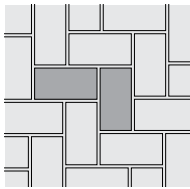

Eco-Priora 5x10 HB

SINGLE UNITS



5 x 10
120 x 240 x 80mm
4¾ x 9½ x 3⅞
245 Units/Bundle
.31 Sq.Ft./Stone

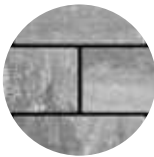

GRANITE FUSION



STEEL GREY



OPAL BLEND

Notes: SOLD IN FULL BUNDLES ONLY and is produced and sold on a required, refundable skid. Important: A urethane rubber paver mat must be used to prevent scuffing when compacting on textured surfaces. All measurements are nominal. Contact Unilock for more information.



APPLICATIONS

Pedestrian, Light Vehicular

APPEARANCE

Edge Detail - Rounded
 Surface Texture - Shot Blasted
 Joint Spacing - 7mm

TECHNICAL INFORMATION

Conforms to ASTM C 936
 Eligible for LEED v4.1 credits

| | | |
|--|----------------|---------|
| | | 4 x 12 |
| | Bundle Type | SINGLE |
| | Plant Produced | ONTARIO |
| | Thickness (mm) | 80 mm |

| | | |
|----------|--------|-------|
| SQFT PER | Stone | 0.32 |
| | Layer | 11.63 |
| | Bundle | 81.38 |

| | | |
|------------|--------|---|
| PER BUNDLE | Layers | 7 |
|------------|--------|---|

| | | |
|------------------|--------|-------|
| SOLDIER LNFT PER | SqFt | 1.02 |
| | Layer | 11.81 |
| | Bundle | 82.68 |

| | | |
|-----------------|--------|--------|
| SAILOR LNFT PER | SqFt | 3.05 |
| | Layer | 35.43 |
| | Bundle | 248.03 |

| | | |
|-----------|--------|------|
| UNITS PER | SqFt | 3.10 |
| | Layer | 36 |
| | Bundle | 252 |

| | | |
|---------|--------|-------|
| LBS PER | Unit | 12 |
| | Layer | 425 |
| | Bundle | 2,978 |

| Colors | Reflectance | Stock |
|------------------|----------------|-------|
| Light Opal Blend | SR n/a sRI n/a | SO |
| Light Steel Grey | SR n/a sRI n/a | SO |

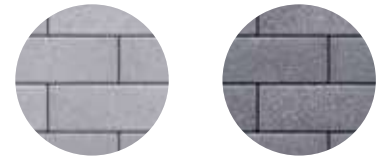

LIGHT OPAL BLEND LIGHT STEEL GREY

LAYING PATTERNS

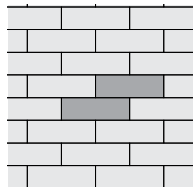

Eco-Promenade
4x12 RB

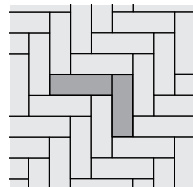

Eco-Promenade
4x12 HB

SINGLE UNIT



4 x 12
 100 x 300 x 80mm
 3 7/8 x 11 7/8 x 3 1/8"
 252 Units/Bundle
 .32 Sq.Ft./Stone

Notes: Special Order. Lead time required. SOLD IN FULL BUNDLES ONLY and is produced and sold on a required, refundable skid. Important: A urethane rubber paver mat must be used to prevent scuffing when compacting on textured surfaces. All measurements are nominal. Contact Unilock for more information.



APPLICATIONS

Pedestrian, Light Vehicular, Roadway Street,
Heavy-duty, Permeable

APPEARANCE

Edge Detail - Micro
Surface Texture - Smooth, Series Exposed,
Umbriano, Revela
Joint Spacing - 7 mm

TECHNICAL INFORMATION

Conforms to ASTM C 936
Eligible for LEED v4.1 credits

| | | |
|----------------|----------|----------|
| | 3 x 12 | 4 x 16 |
| Bundle Type | SINGLE | SINGLE |
| Plant Produced | NEW YORK | NEW YORK |
| Thickness (mm) | 100 mm | 100 mm |

| | | | |
|----------|--------|-------|-------|
| SQFT PER | Stone | 0.24 | 0.43 |
| | Layer | 10.66 | 10.33 |
| | Bundle | 63.94 | 62.00 |

| | | | |
|------------|--------|---|---|
| PER BUNDLE | Layers | 6 | 6 |
|------------|--------|---|---|

| | | | |
|------------------|--------|-------|-------|
| SOLDIER LNFT PER | SqFt | 1.02 | 0.76 |
| | Layer | 10.83 | 7.87 |
| | Bundle | 64.96 | 47.24 |

| | | | |
|-----------------|--------|--------|--------|
| SAILOR LNFT PER | SqFt | 4.06 | 3.05 |
| | Layer | 43.31 | 31.50 |
| | Bundle | 259.84 | 188.98 |

| | | | |
|-----------|--------|------|------|
| UNITS PER | SqFt | 4.13 | 2.32 |
| | Layer | 44 | 24 |
| | Bundle | 264 | 144 |

| | | | |
|---------|--------|-------|-------|
| LBS PER | Unit | 10 | 19 |
| | Layer | 488 | 455 |
| | Bundle | 2,927 | 2,730 |

| Colors | Reflectance | Stock | Stock |
|------------------------------|----------------|-------|-------|
| Multiple Colors and Finishes | SR n/a SRI n/a | SO | SO |

Multiple finishes available by Special Order. Please contact your Territory Manager for more details.

LAYER CONFIGURATION

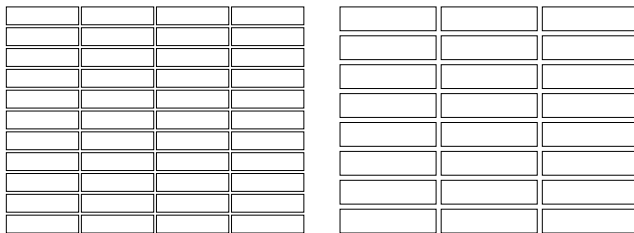

LAYING PATTERNS

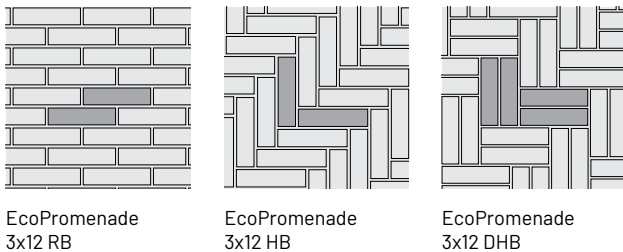

SINGLE UNITS

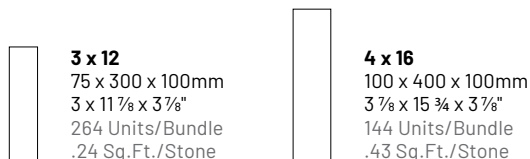

Notes: Made-to-Order. Minimum quantities apply. Lead time required. SOLD IN FULL BUNDLES ONLY and is produced and sold on a required, refundable skid. Important: A urethane rubber paver mat must be used to prevent scuffing when compacting on textured surfaces. All measurements are nominal. Contact Unilock for more information.



APPLICATIONS

Pedestrian, Light Vehicular, Roadway Street,
Heavy-duty, Permeable

APPEARANCE

Edge Detail - Chamfer
Surface Texture - Smooth
Joint Spacing - 6 mm

TECHNICAL INFORMATION

Conforms to ASTM C 936
Eligible for LEED v4.1 credits

| | | |
|------------------------------|--------------------|--------------|
| | | STANDARD |
| | Bundle Type | SINGLE |
| | Plant Produced | NEW YORK |
| | Thickness (mm) | 80 mm |
| SQFT PER | Stone | 0.27 |
| | Layer | 9.57 |
| | Bundle | 67.00 |
| PER BUNDLE | Layers | 7 |
| SOLDIER LNFT PER | SqFt | - |
| | Layer | - |
| | Bundle | - |
| SAILOR LNFT PER | SqFt | - |
| | Layer | - |
| | Bundle | - |
| UNITS PER | SqFt | 3.66 |
| | Layer | 35 |
| | Bundle | 245 |
| LBS PER | Unit | 10 |
| | Layer | 349 |
| | Bundle | 2,445 |
| Colors | Reflectance | Stock |
| Multiple Colors and Finishes | SR n/a SRI n/a | SO |

SINGLE UNIT

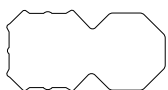

STANDARD
115 x 230 x 80mm
4 5/8 x 9 x 3 1/8"
245 Units/Bundle
.27 SqFt/Stone

Notes: Made-to-Order. Minimum quantities apply. Lead time required. SOLD IN FULL BUNDLES ONLY and is produced and sold on a required, refundable skid. Important: A urethane rubber paver mat must be used to prevent scuffing when compacting on textured surfaces. All measurements are nominal. Contact Unilock for more information.



APPLICATIONS

Pedestrian, Light Vehicular, Roadway Street

APPEARANCE

Edge Detail - Micro

Surface Texture - Multi-surfaces available

Joint Spacing - 3mm

TECHNICAL INFORMATION

Conforms to ASTM C 936

Eligible for LEED v4.1

| | |
|----------------|----------|
| | HEX |
| Bundle Type | SINGLE |
| Plant Produced | NEW YORK |
| Thickness (mm) | 70 mm |

| | | |
|----------|--------|-------|
| SQFT PER | Stone | 0.39 |
| | Layer | 9.24 |
| | Bundle | 73.92 |

| | | |
|------------|--------|---|
| PER BUNDLE | Layers | 8 |
|------------|--------|---|

| | | |
|------------------|--------|---|
| SOLDIER LNFT PER | SqFt | - |
| | Layer | - |
| | Bundle | - |

| | | |
|-----------------|--------|---|
| SAILOR LNFT PER | SqFt | - |
| | Layer | - |
| | Bundle | - |

| | | |
|-----------|--------|------|
| UNITS PER | SqFt | 2.60 |
| | Layer | 24 |
| | Bundle | 192 |

| | | |
|---------|--------|-------|
| LBS PER | Unit | 13 |
| | Layer | 306 |
| | Bundle | 2,450 |

| Colors | Reflectance | Stock |
|----------------------------|----------------|-------|
| Granite Fusion | SR .30 SRI 32 | ✓ |
| Steel Grey | SR .12 SRI 9 | ✓ |
| Opal Blend | SR .48 SRI 56 | ✓ |
| Multiple Colors & Finishes | SR n/a SRI n/a | SO |

LAYER CONFIGURATION

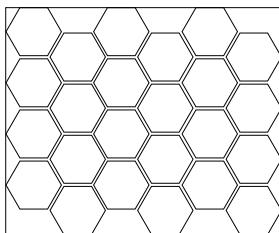

LAYING PATTERNS

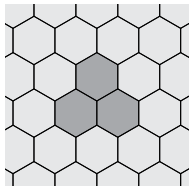

Hex Paver

SINGLE UNIT

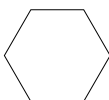

HEX
 200 x 200 x 70mm
 7 7/8 x 7 7/8 x 2 3/4"
 192 Units/Bundle
 .39 SqFt/Stone

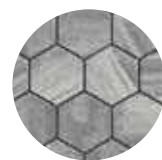

GRANITE FUSION

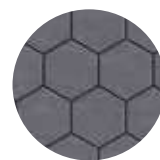

STEEL GREY

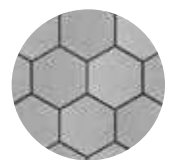

OPAL BLEND

Notes: Minimum quantities apply. **Lead time required for Special Order items. SOLD IN FULL BUNDLES ONLY** and is produced and sold on a required, refundable skid. **Important:** A urethane rubber paver mat must be used to prevent scuffing when compacting. All measurements are nominal. Contact Unilock for more information.



APPLICATIONS

Pedestrian, Light Vehicular, Borders and accents

APPEARANCE

Edge Detail - Chamfer

Surface Texture - Smooth

Joint Spacing - 3 mm

TECHNICAL INFORMATION

Conforms to ASTM C 936

Eligible for LEED v4.1 credits

| | |
|----------------|---------------------|
| | 4 x 8 |
| Bundle Type | SINGLE |
| Plant Produced | NEW YORK / UXBRIDGE |
| Thickness (mm) | 60 mm |

| | | |
|----------|--------|--------|
| SQFT PER | Stone | 0.22 |
| | Layer | 11.80 |
| | Bundle | 118.00 |

| | | |
|------------|--------|----|
| PER BUNDLE | Layers | 10 |
|------------|--------|----|

| | | |
|------------------|--------|--------|
| SOLDIER LNFT PER | SqFt | 1.50 |
| | Layer | 17.72 |
| | Bundle | 177.17 |

| | | |
|-----------------|--------|--------|
| SAILOR LNFT PER | SqFt | 3.00 |
| | Layer | 35.43 |
| | Bundle | 354.33 |

| | | |
|-----------|--------|------|
| UNITS PER | SqFt | 4.58 |
| | Layer | 54 |
| | Bundle | 540 |

| | | |
|---------|--------|-------|
| LBS PER | Unit | 6 |
| | Layer | 330 |
| | Bundle | 3,305 |

| Colors | Reflectance | Stock |
|----------------|----------------|-------|
| Almond Grove | SR .25 SRI 25 | ✓ |
| Dark Charcoal | SR n/a SRI n/a | ✓ |
| Fossil | SR .22 SRI 21 | ✓ |
| Granite Fusion | SR .30 SRI 32 | ✓ |
| Rustic Red | SR .35 SRI 36 | ✓ |

LAYER CONFIGURATION

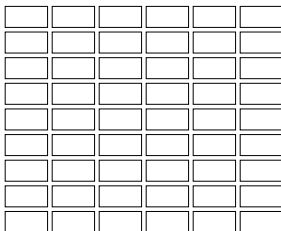

LAYING PATTERNS

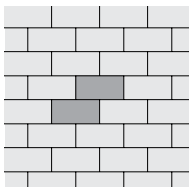

HollandPremier
4x8 RB

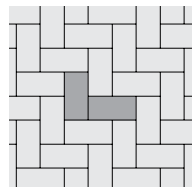

HollandPremier
4x8 HB

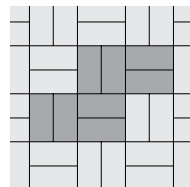

HollandPremier
4x8 BW

SINGLE UNIT



4 x 8
100 x 200 x 60mm
3 7/8 x 7 7/8 x 2 3/8"
540 Units/Bundle
.22 Sq.Ft./Stone



ALMOND GROVE



DARK CHARCOAL



FOSSIL

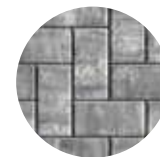

GRANITE FUSION



RUSTIC RED

Notes: SOLD IN FULL BUNDLES ONLY and is produced and sold on a required, refundable skid. **Important: A urethane rubber paver mat must be used to prevent scuffing when compacting on textured surfaces.** All measurements are nominal. Contact Unilock for more information.



APPLICATIONS

Pedestrian, Light Vehicular, Roadway Street, Border/Accents

APPEARANCE

Edge Detail - Rounded
Surface Texture - Il Campo Brushed
Joint Spacing - 3 mm

TECHNICAL INFORMATION

Conforms to ASTM C 936
Eligible for LEED v4.1 credits

| | | |
|----------------|---------|---------|
| | 4 x 8 | 8 x 16 |
| Bundle Type | SINGLE | SINGLE |
| Plant Produced | ONTARIO | ONTARIO |
| Thickness (mm) | 70 mm | 70 mm |

| | | | |
|----------|--------|-------|-------|
| SQFT PER | Stone | 0.22 | 0.86 |
| | Layer | 11.80 | 10.33 |
| | Bundle | 94.40 | 82.67 |

| | | | |
|------------|--------|---|---|
| PER BUNDLE | Layers | 8 | 8 |
|------------|--------|---|---|

| | | | |
|------------------|--------|--------|-------|
| SOLDIER LNFT PER | SqFt | 1.50 | 0.76 |
| | Layer | 17.72 | 7.87 |
| | Bundle | 141.73 | 62.99 |

| | | | |
|-----------------|--------|--------|--------|
| SAILOR LNFT PER | SqFt | 3.00 | 1.52 |
| | Layer | 35.43 | 15.75 |
| | Bundle | 283.46 | 125.98 |

| | | | |
|-----------|--------|------|------|
| UNITS PER | SqFt | 4.58 | 1.16 |
| | Layer | 54 | 12 |
| | Bundle | 432 | 96 |

| | | | |
|---------|--------|-------|-------|
| LBS PER | Unit | 7 | 29 |
| | Layer | 377 | 343 |
| | Bundle | 3,019 | 2,747 |

| Colors | Reflectance | Stock | Stock |
|---------------|----------------|-------|-------|
| Dark Charcoal | SR n/a SRI n/a | SO | SO |
| Granite | SR n/a SRI n/a | - | SO |
| Light Grey | SR .22 SRI 22 | - | SO |
| Sandstone | SR n/a SRI n/a | - | SO |

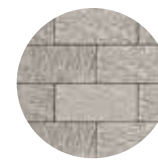
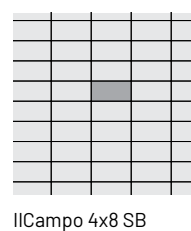
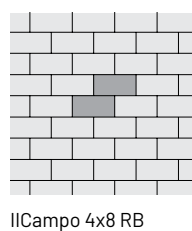
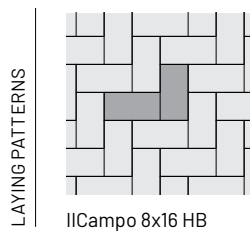

LIGHT GREY



SANDSTONE

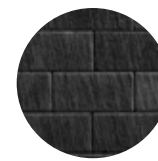

DARK CHARCOAL



GRANITE

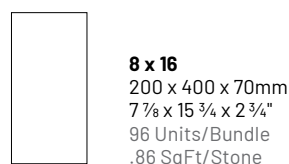
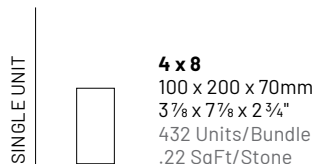

Notes: Special Order. Lead time required. SOLD IN FULL BUNDLES ONLY and is produced and sold on a required, refundable skid. Important: A urethane rubber paver mat must be used to prevent scuffing when compacting. All measurements are nominal. Contact Unilock for more information.



APPLICATIONS

Pedestrian, Light Vehicular, Border/Accents

APPEARANCE

Edge Detail - Zero

Surface Texture - Smooth

Joint Spacing - 4 mm

TECHNICAL INFORMATION

Conforms to ASTM C 936

Eligible for LEED v4.1 credits

| | |
|----------------|-----------------|
| | STANDARD SMOOTH |
| Bundle Type | SINGLE |
| Plant Produced | NEW YORK |
| Thickness (mm) | 70 mm |

| | | |
|----------|--------|-------|
| SQFT PER | Stone | 0.16 |
| | Layer | 10.85 |
| | Bundle | 86.80 |

| | | |
|------------|--------|---|
| PER BUNDLE | Layers | 8 |
|------------|--------|---|

| | | |
|------------------|--------|--------|
| SOLDIER LNFT PER | SqFt | 1.27 |
| | Layer | 13.78 |
| | Bundle | 110.23 |

| | | |
|-----------------|--------|--------|
| SAILOR LNFT PER | SqFt | 5.08 |
| | Layer | 55.12 |
| | Bundle | 440.94 |

| | | |
|-----------|--------|------|
| UNITS PER | SqFt | 6.45 |
| | Layer | 70 |
| | Bundle | 560 |

| | | |
|---------|--------|-------|
| LBS PER | Unit | 5 |
| | Layer | 350 |
| | Bundle | 2,797 |

| Colors | Reflectance | Stock |
|----------------|----------------|-------|
| Granite Fusion | SR .30 SRI 32 | ✓ |
| Sable Blend | SR .38 SRI 42 | ✓ |
| Cocoa Brown | SR .34 SRI 37 | ✓ |
| Dark Charcoal | SR n/a SRI n/a | ✓ |

LAYER CONFIGURATION

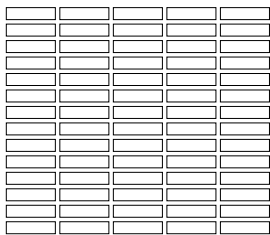

LAYING PATTERNS

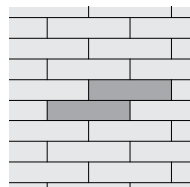
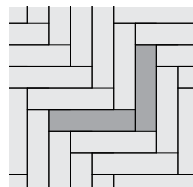
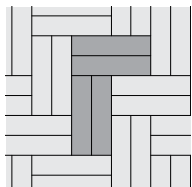

Mattoni DHB

Mattoni HB

Mattoni RB

SINGLE UNIT



STANDARD

60 x 240 x 70mm
 2 3/8 x 9 1/2 x 2 3/4"
 560 Units/Bundle
 .16 SqFt/Stone



COCOA BROWN



SABLE BLEND



DARK CHARCOAL

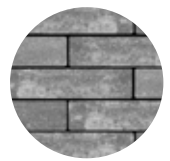

GRANITE FUSION

Notes: SOLD IN FULL BUNDLES ONLY and is produced and sold on a required, refundable skid. Important: A urethane rubber paver mat must be used to prevent scuffing when compacting. All measurements are nominal. Contact Unilock for more information.

Natural Stone Slabs



APPLICATIONS

Pedestrian, Roof Deck

APPEARANCE

Edge Detail - Sawn

Surface Texture - Brushed / Riven

Joint Spacing - 10 mm

TECHNICAL INFORMATION

Visit Unilock.com for more information.

| SANDSTONE | 12 x 24 | 18 x 24 | 24 x 24 | 24 x 36 |
|----------------|---------|---------|---------|---------|
| Bundle Type | SINGLE | SINGLE | SINGLE | SINGLE |
| Thickness (mm) | 22 mm | 22 mm | 22 mm | 22 mm |

| SQFT PER | Crate | 180.00 | 186.00 | 160.00 | 180.00 |
|----------|-------|--------|--------|--------|--------|
| | Units | 2.00 | 3.00 | 4.00 | 6.00 |

| UNITS PER | Crate | 90 | 62 | 40 | 30 |
|-----------|-------|------|------|------|------|
| | SqFt | 0.50 | 0.33 | 0.25 | 0.17 |

| LBS PER | Unit | 24 | 36 | 48 | 72 |
|---------|-------|-------|-------|-------|-------|
| | Crate | 2,033 | 2,136 | 1,836 | 2,072 |

| Colors | Reflectance | Stock | Stock | Stock | Stock |
|------------------|----------------|-------|-------|-------|-------|
| Cascade | SR n/a SRI n/a | ✓ | ✓ | ✓ | ✓ |
| Greyfield | SR .32 SRI 35 | ✓ | ✓ | ✓ | ✓ |
| Stone Cliff Grey | SR .27 SRI 28 | ✓ | ✓ | ✓ | ✓ |

| LIMESTONE | 12 x 24 | 18 x 24 | 24 x 24 | 24 x 36 |
|----------------|---------|---------|---------|---------|
| Bundle Type | SINGLE | SINGLE | SINGLE | SINGLE |
| Thickness (mm) | 22 mm | 22 mm | 22 mm | 22 mm |

| SQFT PER | Crate | 180.00 | 186.00 | 160.00 | 180.00 |
|----------|-------|--------|--------|--------|--------|
| | Units | 2.00 | 3.00 | 4.00 | 6.00 |

| UNITS PER | Crate | 90 | 62 | 40 | 30 |
|-----------|-------|------|------|------|------|
| | SqFt | 0.50 | 0.33 | 0.25 | 0.17 |

| LBS PER | Unit | 24 | 36 | 48 | 72 |
|---------|-------|-------|-------|-------|-------|
| | Crate | 2,033 | 2,136 | 1,836 | 2,072 |

| Colors | Reflectance | Stock | Stock | Stock | Stock |
|-------------|---------------|-------|-------|-------|-------|
| Black River | SR .08 SRI 4 | ✓ | ✓ | ✓ | ✓ |
| Hearthstone | SR .20 SRI 20 | ✓ | ✓ | ✓ | ✓ |

LAYING PATTERNS

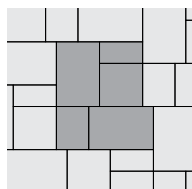

NaturalStone Multi-Unit

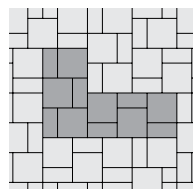

NaturalStone Multi-Unit

SINGLE UNITS

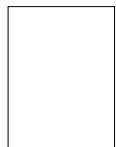

12 x 24
290 x 590 x 22mm
11 1/2 x 23 1/4 x 7/8"

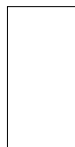

18 x 24
440 x 590 x 22mm
17 3/8 x 23 1/4 x 7/8"



24 x 36
590 x 890 x 22mm
23 1/4 x 35 x 7/8"

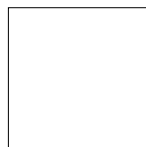

24 x 24
590 x 590 x 22mm
23 1/4 x 23 1/4 x 7/8"



BLACK RIVER



CASCADE



GREYFIELD



STONE CLIFF GREY



HEARTHSTONE

Notes: SOLD IN FULL CRATES ONLY It is recommended to install these units with a 10 mm joint space between stones. This product is not intended for vehicular applications. Due to natural oxidation, the Black River Limestone will require sealing to maintain its deep rich color. Unilock recommends a solvent-based sealer for natural stone. All measurements are nominal. Contact Unilock for more information.

Natural Stone Random Bundle



APPLICATIONS

Pedestrian

APPEARANCE

Edge Detail - Sawn

Surface Texture - Natural Finish

Joint Spacing - 10 mm

TECHNICAL INFORMATION

Visit Unilock.com for more information.

LAYING PATTERNS

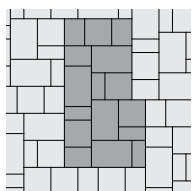

NaturalStone
Fixed RB

4 UNIT RANDOM

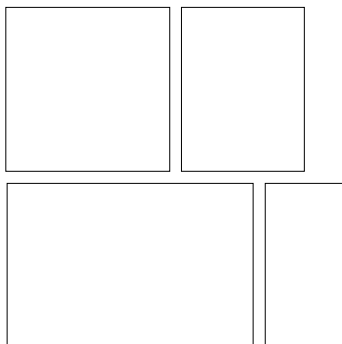

24 x 24
590 x 590 x 38mm
23 1/4 x 23 1/4 x 1 1/2"

18 x 24
440 x 590 x 38mm
17 3/8 x 23 1/4 x 1 1/2"

24 x 36
590 x 890 x 38mm
23 1/4 x 35 x 1 1/2"

12 x 24
290 x 590 x 38mm
11 1/2 x 23 1/4 x 1 1/2"

| SANDSTONE | | 4 PC BUNDLE |
|----------------|--|-------------|
| Bundle Type | | RANDOM |
| Thickness (mm) | | 38 mm |

| | | |
|----------|-------|--------|
| SQFT PER | Crate | 120.00 |
| | Units | - |

| | | |
|-----------|-------|----|
| UNITS PER | Crate | 32 |
| | SqFt | - |

| | | |
|---------|--------|-------|
| LBS PER | Unit | - |
| | Bundle | 2,515 |

| Colors | Reflectance | Stock |
|------------------|---------------|-------|
| Stone Cliff Grey | SR .27 SRI 28 | ✓ |

| LIMESTONE | | 4 PC BUNDLE |
|----------------|--|-------------|
| Bundle Type | | RANDOM |
| Thickness (mm) | | 38 mm |

| | | |
|----------|-------|--------|
| SQFT PER | Crate | 120.00 |
| | Units | - |

| | | |
|-----------|-------|----|
| UNITS PER | Crate | 32 |
| | SqFt | - |

| | | |
|---------|--------|-------|
| LBS PER | Unit | - |
| | Bundle | 2,315 |

| Colors | Reflectance | Stock |
|-------------|----------------|-------|
| Hearthstone | SR n/a SRI n/a | ✓ |



STONE CLIFF GREY



HEARTHSTONE

Notes: SOLD IN FULL CRATES ONLY. This project pack must be installed with a 10 mm joint space between stones. This product is not intended for vehicular applications. All measurements are nominal. Contact Unilock for more information.

Natural Stone Coping



APPLICATIONS

Wall Coping, Pool Coping, Steps Treads



CASCADE



GREYFIELD



STONE CLIFF GREY



BLACK RIVER

| SANDSTONE | | 48 x 12 FULLNOSE COPING | 48 x 12 STRAIGHT EDGE COPING | 48 x 12 ROCKFACE COPING | 48 x 14 FULLNOSE COPING | 48 x 14 STRAIGHT COPING | 48 x 14 ROCKFACE COPING |
|----------------|--|-------------------------------|------------------------------------|-------------------------------|-------------------------------|-------------------------------|-------------------------------|
| Bundle Type | | SINGLE | SINGLE | SINGLE | SINGLE | SINGLE | SINGLE |
| Thickness (mm) | | 50 mm | 50 mm | 50 mm | 50 mm | 50 mm | 50 mm |

| UNITS PER | Crate | 20 | 20 | 20 | 20 | 20.00 | 20.00 |
|-----------|-------|------|------|------|------|-------|-------|
| | SqFt | 4.00 | 4.00 | 4.00 | 4.67 | 4.67 | 4.67 |

| LBS PER | Unit | 97 | 97 | 97 | 117 | 117 | 117 |
|---------|-------|-------|-------|-------|-------|-------|-------|
| | Crate | 1,927 | 1,927 | 1,927 | 2,560 | 2,337 | 2,337 |

| Colors | Reflectance | Stock | Stock | Stock | Stock | Stock | Stock |
|------------------|----------------|-------|-------|-------|-------|-------|-------|
| Cascade | SR n/a SRI n/a | ✓ | ✓ | ✓ | ✓ | ✓ | ✓ |
| Greyfield | SR n/a SRI n/a | ✓ | ✓ | ✓ | ✓ | ✓ | ✓ |
| Stone Cliff Grey | SR n/a SRI n/a | ✓ | ✓ | ✓ | ✓ | ✓ | ✓ |

| LIMESTONE | | 48 x 12 FULLNOSE COPING | 48 x 12 STRAIGHT EDGE COPING | 48 x 12 ROCKFACE COPING | 48 x 14 FULLNOSE COPING | 48 x 14 STRAIGHT COPING | 48 x 14 ROCKFACE COPING |
|----------------|--|-------------------------------|------------------------------------|-------------------------------|-------------------------------|-------------------------------|-------------------------------|
| Bundle Type | | SINGLE | SINGLE | SINGLE | SINGLE | SINGLE | SINGLE |
| Thickness (mm) | | 50 mm | 50 mm | 50 mm | 50 mm | 50 mm | 50 mm |

| UNITS PER | Crate | 20 | 20 | 20 | 20 | 20 | 20 |
|-----------|-------|------|------|------|------|------|------|
| | SqFt | 4.00 | 4.00 | 4.00 | 4.67 | 4.67 | 4.67 |

| LBS PER | Unit | 112 | 112 | 112 | 130 | 130 | 130 |
|---------|-------|-------|-------|-------|-------|-------|-------|
| | Crate | 2,222 | 2,222 | 2,222 | 2,593 | 2,593 | 2,593 |

| Colors | Reflectance | Stock | Stock | Stock | Stock | Stock | Stock |
|-------------|----------------|-------|-------|-------|-------|-------|-------|
| Black River | SR n/a SRI n/a | ✓ | ✓ | ✓ | ✓ | ✓ | ✓ |

COPING

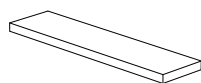

48 x 12
1,200 x 300 x 50mm
47 1/2 x 11 7/8 x 2"

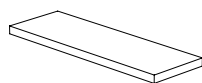

48 x 14
1,200 x 355 x 50mm
47 1/2 x 14 x 2"

EDGE DETAIL



ROCKFACE



FULLNOSE



STRAIGHT EDGE

Notes: Steps, Coping & Pillar Caps require a refundable skid. This product is not intended for vehicular applications. Due to natural oxidation, the Black River Limestone will require sealing to maintain its deep rich color. Unilock recommends a solvent-based sealer for natural stone. All measurements are nominal. Contact Unilock for more information.

Natural Stone Coping



APPLICATIONS

Wall Coping, Pool Coping, Steps Treads



CASCADE



GREYFIELD



STONE CLIFF GREY



BLACK RIVER

| SANDSTONE | | 28 x 14 FULLNOSE CORNER / COPING | 28 x 14 STRAIGHT CORNER / COPING | 24 x 12 FULLNOSE CORNER / COPING | 24 x 12 STRAIGHT CORNER / COPING | 24 x 24 INSERT COPING |
|-----------|----------------|--|--|--|--|-----------------------------|
| | Bundle Type | SINGLE | SINGLE | SINGLE | SINGLE | SINGLE |
| | Thickness (mm) | 50 mm | 50 mm | 50 mm | 50 mm | 50 mm |

| UNITS PER | Crate | 20 | 20 | 20 | 20 | 20 |
|-----------|-------|------|------|-----|-----|------|
| | SqFt | 4.67 | 4.67 | 3.0 | 3.0 | 4.67 |

| LBS PER | Unit | 113 | 113 | 91 | 91 | 106 |
|---------|-------|-------|-------|-------|-------|-------|
| | Crate | 2,249 | 2,249 | 1,808 | 1,808 | 2,120 |

| Colors | Reflectance | Stock | Stock | Stock | Stock | Stock |
|------------------|----------------|-------|-------|-------|-------|-------|
| Cascade | SR n/a SRI n/a | ✓ | ✓ | ✓ | ✓ | ✓ |
| Greyfield | SR n/a SRI n/a | ✓ | ✓ | ✓ | ✓ | ✓ |
| Stone Cliff Grey | SR n/a SRI n/a | ✓ | ✓ | ✓ | ✓ | ✓ |

| LIMESTONE | | 28 X 14 FULLNOSE CORNER / COPING | 28 X 14 STRAIGHT CORNER / COPING | 24 X 12 FULLNOSE CORNER / COPING | 24 X 12 STRAIGHT CORNER / COPING | 24 X 24 INSERT COPING |
|-----------|----------------|--|--|--|--|-----------------------------|
| | Bundle Type | SINGLE | SINGLE | SINGLE | SINGLE | SINGLE |
| | Thickness (mm) | 50 mm | 50 mm | 50 mm | 50 mm | 50 mm |

| UNITS PER | Crate | 20 | 20 | 20 | 20 | 20 |
|-----------|-------|------|------|-----|-----|-----|
| | SqFt | 4.08 | 4.08 | 3.0 | 3.0 | 4.0 |

| LBS PER | Unit | 117 | 117 | 84 | 84 | 90 |
|---------|-------|-------|-------|-------|-------|-------|
| | Crate | 2,237 | 2,237 | 1,676 | 1,676 | 1,800 |

| Colors | Reflectance | Stock | Stock | Stock | Stock | Stock |
|-------------|----------------|-------|-------|-------|-------|-------|
| Black River | SR n/a SRI n/a | ✓ | ✓ | ✓ | ✓ | ✓ |

INSERT COPING

Insert coping is ideal for those retractable pool covers. Allowing easy access while keeping a continuous look and feel.

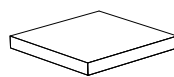

24 x 24
600 x 600 x 50mm
24 x 24 x 2"

CORNER COPING

Corner coping provides seamless 90° corners for pool, walls and so much more.

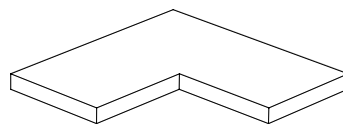

28 x 14
710 x 355 x 50mm
28 x 14 x 2"

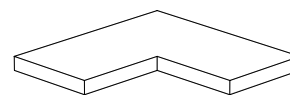

24 x 12
600 x 300 x 50mm
23 5/8 x 11 7/8 x 2"

EDGE DETAIL



STRAIGHT EDGE



FULLNOSE

Notes: Steps, Coping & Pillar Caps require a refundable skid. This product is not intended for vehicular applications. Due to natural oxidation, the Black River Limestone will require sealing to maintain its deep rich color. Unilock recommends a solvent-based sealer for natural stone. All measurements are nominal. Contact Unilock for more information.

Natural Stone Steps & Pillar Caps



APPLICATIONS

Steps, Pillar

TECHNICAL INFORMATION

Visit Unilock.com for more information.



CASCADE



GREYFIELD



STONE CLIFF GREY



BLACK RIVER

| SANDSTONE | | 24 x 24 PILLAR CAP | 28 x 28 PILLAR CAP | 48 x 16 STEP |
|------------------|----------------|-----------------------|-----------------------|-----------------|
| Bundle Type | | SINGLE | SINGLE | SINGLE |
| Thickness (mm) | | 64 mm | 64 mm | 150 mm |
| LNFT PER | Crate | 28.00 | 28.00 | 24.00 |
| | Unit | 2.33 | 2.33 | 4.00 |
| UNITS PER | Crate | 14 | 12 | 6 |
| LBS PER | Unit | 143 | 199 | 421 |
| | Crate | 1,991 | 2,385 | 2,526 |
| Colors | Reflectance | Stock | Stock | Stock |
| Cascade | SR n/a SRI n/a | ✓ | ✓ | ✓ |
| Greyfield | SR n/a SRI n/a | ✓ | ✓ | ✓ |
| Stone Cliff Grey | SR n/a SRI n/a | ✓ | ✓ | ✓ |

| LIMESTONE | | 24 x 24 PILLAR CAP | 28 x 28 PILLAR CAP | 48 x 16 STEP |
|----------------|----------------|-----------------------|-----------------------|-----------------|
| Bundle Type | | SINGLE | SINGLE | SINGLE |
| Thickness (mm) | | 64 mm | 64 mm | 150 mm |
| LNFT PER | Crate | 28.00 | 28.00 | 24.00 |
| | Unit | 2.33 | 2.33 | 4.00 |
| UNITS PER | Crate | 14 | 12 | 6 |
| LBS PER | Unit | 143 | 207 | 421 |
| | Crate | 1,995 | 2,480 | 2,526 |
| Colors | Reflectance | Stock | Stock | Stock |
| Black River | SR n/a SRI n/a | ✓ | ✓ | ✓ |

PILLAR CAPS

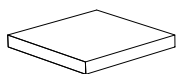

24 x 24
600 x 600 x 64mm
23 5/8 x 23 5/8 x 2 5/8"

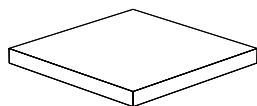

28 x 28
710 x 710 x 64mm
28 x 28 x 2 5/8"

STEPS

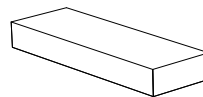

48 x 16
1,200 x 400 x 150mm
47 1/4 x 15 3/4 x 5 7/8"

EDGE DETAIL



STRAIGHT EDGE



ROCKFACE

Notes: This product is not intended for vehicular applications. Due to natural oxidation, the Black River Limestone will require sealing to maintain its deep rich color. Unilock recommends a solvent-based sealer for natural stone. All measurements are nominal. Contact Unilock for more information.



APPLICATIONS

Pedestrian, Light Vehicular, Roadway Street,
Heavy-duty, Permeable

APPEARANCE

Edge Detail - Zero
Surface Texture - Textured

TECHNICAL INFORMATION

Conforms to ASTM C 936
Eligible for LEED v4.1

| | |
|----------------|---------|
| Bundle Type | SINGLE |
| Plant Produced | ONTARIO |
| Thickness (mm) | 60 mm |

| | | |
|----------|--------|-------|
| SQFT PER | Stone | 0.09 |
| | Layer | 9.83 |
| | Bundle | 58.95 |

| | | |
|------------|--------|---|
| PER BUNDLE | Layers | 6 |
|------------|--------|---|

| | | |
|------------------|--------|--------|
| SOLDIER LNFT PER | SqFt | 3.39 |
| | Layer | 33.31 |
| | Bundle | 199.84 |

| | | |
|-----------------|--------|---|
| SAILOR LNFT PER | SqFt | - |
| | Layer | - |
| | Bundle | - |

| | | |
|-----------|--------|-------|
| UNITS PER | SqFt | 10.99 |
| | Layer | 108 |
| | Bundle | 648 |

| | | |
|---------|--------|-------|
| LBS PER | Unit | 3 |
| | Layer | 270 |
| | Bundle | 1,618 |

| Colors | Reflectance | Stock |
|----------------|----------------|-------|
| Dark Charcoal | SR n/a SRI n/a | ✓ |
| Granite Fusion | SR n/a SRI n/a | ✓ |
| Opal Blend | SR n/a SRI n/a | ✓ |

LAYER CONFIGURATION

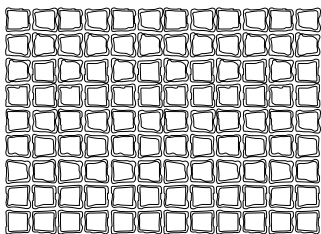

LAYING PATTERNS

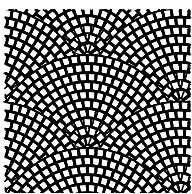

NordicCobble_Fan

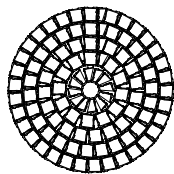

NordicCobble_Circle

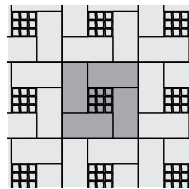

NordicCobble

SINGLE UNIT



STANDARD

89.9 x 94 x 60mm
3 5/8 x 3 3/4 x 2 3/8"
648 Units/Bundle
.09 Sq.Ft./Stone

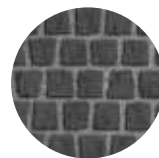

DARK CHARCOAL



OPAL BLEND

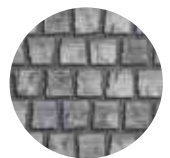

GRANITE FUSION

Notes: **SOLD IN FULL BUNDLES ONLY** and is produced and sold on a required, refundable skid. **Important: A urethane rubber paver mat must be used to prevent scuffing when compacting on textured surfaces.** All measurements are nominal. Contact Unilock for more information.



APPLICATIONS

Pedestrian, Light Vehicular, Roadway Street, Heavy-duty

APPEARANCE

Edge Detail - Chamfer

Surface Texture - Smooth

Joint Spacing - 8 mm

TECHNICAL INFORMATION

Conforms to ASTM C 936

Eligible for LEED v4.1 credits

| | | STANDARD |
|--|----------------|---------------------|
| | Bundle Type | SINGLE |
| | Plant Produced | NEW YORK / UXBRIDGE |
| | Thickness (mm) | 80 mm |

| | | |
|-----------------|--------|-------|
| SQFT PER | Stone | 0.55 |
| | Layer | 9.82 |
| | Bundle | 68.76 |

| | | |
|-------------------|--------|---|
| PER BUNDLE | Layers | 7 |
|-------------------|--------|---|

| | | |
|-------------------------|--------|---|
| SOLDIER LNFT PER | SqFt | - |
| | Layer | - |
| | Bundle | - |

| | | |
|------------------------|--------|---|
| SAILOR LNFT PER | SqFt | - |
| | Layer | - |
| | Bundle | - |

| | | |
|------------------|--------|------|
| UNITS PER | SqFt | 1.83 |
| | Layer | 18 |
| | Bundle | 126 |

| | | |
|----------------|--------|-------|
| LBS PER | Unit | 20 |
| | Layer | 359 |
| | Bundle | 2,516 |

| Colors | Reflectance | Stock |
|------------------------------|----------------|-----------|
| Multiple Colors and Finishes | SR n/a SRI n/a | SO |

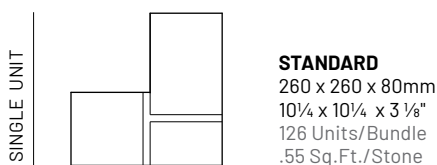
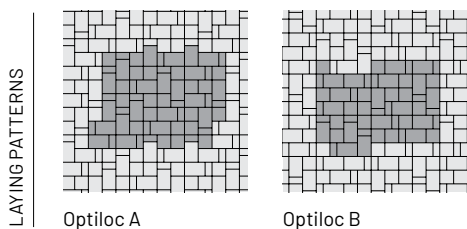
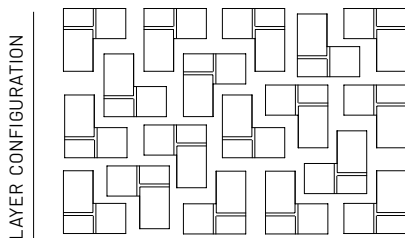

Notes: Made-to-Order. Minimum quantities apply. **Lead time required. SOLD IN FULL BUNDLES ONLY** and is produced and sold on a required, refundable skid. **Important: A urethane rubber paver mat must be used to prevent scuffing when compacting on textured surfaces.** All measurements are nominal. Contact Unilock for more information.



APPLICATIONS

Pedestrian, Roof Deck

APPEARANCE

Edge Detail - n/a

Surface Texture - Stone Finish

Joint Spacing - n/a

TECHNICAL INFORMATION

Visit Unilock.com for more information.



NATURE CARRARA



NATURE DOLOMITE



NEW ENGL. WHITE



GOTHAM GREY



GOTHAM NERO



GOTHAM BIANCO



NEW ENGL. IVORY

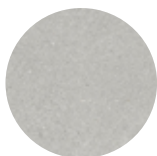

NEW ENGL. COLD GRAY



TRAVSTONE BEIGE



TRAVSTONE GRAY



QUARTZITE DARK GRAY



QUARTZITE SAND

| | 24 X 24 PRESSED EDGE | 16 X 32 PRESSED EDGE |
|----------------|-------------------------|-------------------------|
| Bundle Type | SINGLE | SINGLE |
| Thickness (mm) | 20 mm | 20 mm |

| SQFT PER | Pallet | 248 | 165 |
|----------|--------|------|------|
| | Box | 7.75 | 6.89 |
| | Unit | 3.88 | 3.45 |

| PER PALLET | Box | 32.00 | 24.00 |
|------------|------|--------|--------|
| | SqFt | 248.00 | 165.71 |
| | Unit | 64.00 | 48.00 |

| UNITS PER | Pallet | 64 | 48 |
|-----------|--------|----|----|
| | Box | 2 | 2 |

| LBS PER | Unit | 36 | 32 |
|---------|--------|-------|-------|
| | SqFt | 9 | 9 |
| | Box | 72 | 64 |
| | Pallet | 2,277 | 1,538 |

| Colors | Reflectance | Stock | Stock |
|-----------------------|----------------|-------|-------|
| Gotham Grey | SR n/a SRI n/a | SO | - |
| Gotham Nero | SR n/a SRI n/a | SO | - |
| Gotham Bianco | SR n/a SRI n/a | SO | - |
| Nature Carrara | SR n/a SRI n/a | SO | - |
| Nature Dolomite | SR n/a SRI n/a | SO | - |
| New England White | SR n/a SRI n/a | SO | SO |
| New England Ivory | SR n/a SRI n/a | SO | SO |
| New England Cold Gray | SR n/a SRI n/a | SO | SO |
| Travstone Beige | SR n/a SRI n/a | SO | SO |
| Travstone Gray | SR n/a SRI n/a | SO | SO |
| Quartzite Dark Gray | SR n/a SRI n/a | - | SO |
| Quartzite Sand | SR n/a SRI n/a | - | SO |

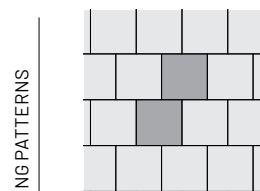

Porcelain 24x24 RB

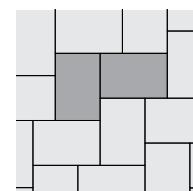

Porcelain 16x32 HB

LAYING PATTERNS

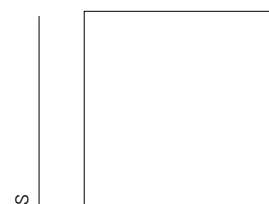

DEL CONCA 24 x 24
600 x 600 x 20mm
23⁵/₈ x 23⁵/₈ x 3/4"
3.88 Sq.Ft./Stone



DEL CONCA 16 x 32
400 x 800 x 20mm
15 3/4 x 31 1/2 x 3/4"
3.45 Sq.Ft./Stone

SINGLE UNITS

Notes: Special Order. Lead time required. All measurements are nominal. Contact Unilock for more information. Porcelain tile is not covered by Unilock's Lifetime Guarantee. Please contact your Territory Manager for more information. Product is not intended for vehicular applications.



APPLICATIONS

Pedestrian, Light Vehicular, Roadway Street, Heavy-duty

APPEARANCE

Edge Detail - Rounded

Surface Texture - Smooth, Series™ Exposed,

Il Campo Brushed

Joint Spacing - 4 mm

TECHNICAL INFORMATION

Conforms to ASTM C 936

Eligible for LEED v4.1 credits

| | | 3 x 12 | 4 x 12 | 6 x 12 | 4 x 16 | 8 x 24 |
|------------------------------|--------------------|-----------|--------------|--------------|--------------|--------------|
| | Bundle Type | SINGLE | SINGLE | SINGLE | SINGLE | SINGLE |
| | Plant Produced | NEW YORK | NEW YORK | NEW YORK | NEW YORK | NEW YORK |
| | Thickness (mm) | 100 mm | 100 mm | 100 mm | 100 mm | 100 mm |
| SQFT PER | Stone | 0.24 | 0.32 | 0.48 | 0.43 | 1.29 |
| | Layer | 10.66 | 11.63 | 11.63 | 10.33 | 10.33 |
| | Bundle | 63.94 | 69.76 | 69.76 | 62.00 | 62.00 |
| PER BUNDLE | Layers | 6 | 6 | 6 | 6 | 6 |
| SOLDIER LNFT PER | SqFt | 1.35 | 1.02 | 1.02 | 0.76 | 0.51 |
| | Layer | 14.44 | 11.81 | 11.81 | 7.87 | 5.25 |
| | Bundle | 86.61 | 70.87 | 70.87 | 47.24 | 31.50 |
| SAILOR LNFT PER | SqFt | 4.06 | 3.05 | 2.03 | 3.05 | 1.52 |
| | Layer | 43.31 | 35.43 | 23.62 | 31.50 | 15.75 |
| | Bundle | 259.84 | 212.60 | 141.73 | 188.98 | 94.49 |
| UNITS PER | SqFt | 4.13 | 3.10 | 2.06 | 2.32 | 0.77 |
| | Layer | 44 | 36 | 24 | 24 | 8 |
| | Bundle | 264 | 216 | 144 | 144 | 48 |
| LBS PER | Unit | 10 | 15 | 21 | 19 | 60 |
| | Layer | 448 | 532 | 514 | 455 | 478 |
| | Bundle | 2,685 | 3,191 | 3,082 | 2,730 | 2,869 |
| Colors | Reflectance | | Stock | Stock | Stock | Stock |
| Multiple Colors and Finishes | SR n/a SRI n/a | SO | SO | SO | SO | SO |

Multiple finishes available by Special Order.

Please contact your Territory Manager for more details.

LAYING PATTERNS

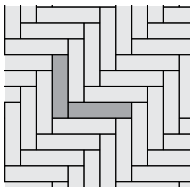

Promenade
4x16 HB

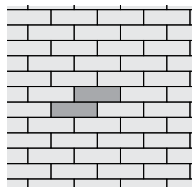

Promenade
4x12 RB

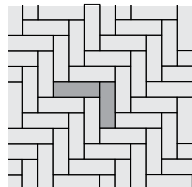

Promenade
4x12 HB

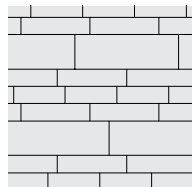

Promenade
Multi-Unit Random

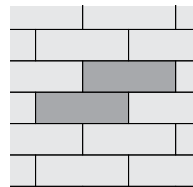

Promenade
8x24 RB

SINGLE UNITS

3 x 12
75 x 300 x 100mm
3 x 11 7/8 x 3 7/8"
264 Units/Bundle
.24 Sq.Ft./Stone

4 x 12
100 x 300 x 100mm
3 7/8 x 11 7/8 x 3 7/8"
216 Units/Bundle
.32 Sq.Ft./Stone

4 x 16
100 x 400 x 100mm
3 7/8 x 15 3/4 x 3 7/8"
144 Units/Bundle
.43 Sq.Ft./Stone

6 x 12
150x300x100mm
5 7/8 x 11 7/8 x 3 7/8"
144 Units/Bundle
.48 Sq.Ft./Stone

8 x 24
200 x 600 x 100mm
7 7/8 x 23 5/8 x 3 7/8"
48 Units/Bundle
1.29 Sq.Ft./Stone

Notes: Made-to-Order. Minimum quantities apply. **Lead time required. SOLD IN FULL BUNDLES ONLY** and is produced and sold on a required, refundable skid. **Important: A urethane rubber paver mat must be used to prevent scuffing when compacting on textured surfaces.** All measurements are nominal. Contact Unilock for more information.



APPLICATIONS

Pedestrian, Light Vehicular, Roadway Street

APPEARANCE

Edge Detail - Rounded

Surface Texture - Smooth & Series™ Exposed,

Umbriano Mottled

Joint Spacing - 4 mm

TECHNICAL INFORMATION

Conforms to ASTM C 936

Eligible for LEED v4.1 credits

| | | 4 x 12 | 6 x 24 | 8 x 24 |
|------------------------------|----------------|----------|----------|----------|
| | Bundle Type | SINGLE | SINGLE | SINGLE |
| | Plant Produced | NEW YORK | NEW YORK | NEW YORK |
| | Thickness (mm) | 70 mm | 70 mm | 70 mm |
| SQFT PER | Stone | 0.32 | 0.97 | 1.29 |
| | Layer | 11.63 | 11.63 | 10.33 |
| | Bundle | 93.04 | 93.00 | 82.67 |
| PER BUNDLE | Layers | 8 | 8 | 8 |
| SOLDIER LNFT PER | SqFt | 1.02 | 0.51 | 0.51 |
| | Layer | 11.81 | 5.91 | 5.25 |
| | Bundle | 94.49 | 47.24 | 41.99 |
| SAILOR LNFT PER | SqFt | 3.05 | 2.03 | 1.02 |
| | Layer | 35.43 | 23.62 | 10.50 |
| | Bundle | 283.46 | 188.98 | 83.99 |
| UNITS PER | SqFt | 3.10 | 1.03 | 0.77 |
| | Layer | 36 | 12 | 8 |
| | Bundle | 288 | 96 | 64 |
| LBS PER | Unit | 11 | 31 | 41 |
| | Layer | 393 | 372 | 331 |
| | Bundle | 3,140 | 2,977 | 2,647 |
| Colors | Reflectance | Stock | Stock | Stock |
| Multiple Colors and Finishes | SR n/a SRI n/a | S0 | S0 | S0 |

Multiple finishes available by Special Order.

Please contact your Territory Manager for more details.

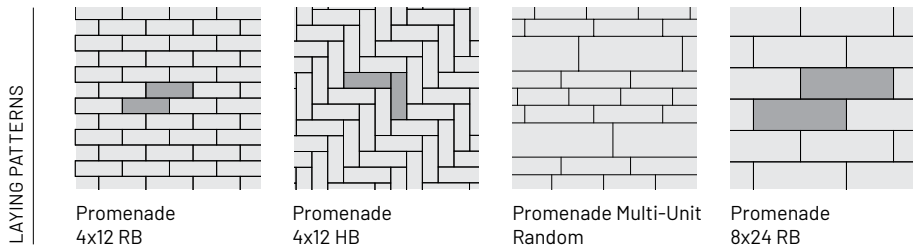

SINGLE UNITS

4 x 12
100 x 300 x 70mm
3 7/8 x 11 7/8 x 2 3/4"
288 Units/Bundle
.32 Sq.Ft./Stone

6 x 24
150 x 600 x 70mm
5 7/8 x 23 5/8 x 2 3/4"
96 Units/Bundle
.97 Sq.Ft./Stone

8 x 24
200 x 600 x 70mm
7 7/8 x 23 5/8 x 2 3/4"
64 Units/Bundle
1.29 Sq.Ft./Stone

Notes: Made-to-Order. Minimum quantities apply. **Lead time required. SOLD IN FULL BUNDLES ONLY** and is produced and sold on a required, refundable skid. **Important: A urethane rubber paver mat must be used to prevent scuffing when compacting on textured surfaces.** All measurements are nominal. Contact Unilock for more information.



APPLICATIONS

Pedestrian, Light Vehicular

APPEARANCE

Edge Detail - Rounded
 Surface Texture - Textured
 Joint Spacing - 10 mm

TECHNICAL INFORMATION

Conforms to ASTM C 936
 Eligible for LEED v4.1

| | | |
|----------------|--------|-----------------|
| | | LARGE RECTANGLE |
| Bundle Type | RANDOM | SINGLE |
| Plant Produced | AYR | AYR |
| Thickness (mm) | 60 mm | 60 mm |

| | | | |
|----------|--------|-------|-------|
| SQFT PER | Stone | - | 1.72 |
| | Layer | 11.29 | 10.30 |
| | Bundle | 90.30 | 82.39 |

| | | | |
|------------|--------|---|---|
| PER BUNDLE | Layers | 8 | 8 |
|------------|--------|---|---|

| | | | |
|------------------|--------|---|-------|
| SOLDIER LNFT PER | SqFt | - | 0.58 |
| | Layer | - | 5.94 |
| | Bundle | - | 47.56 |

| | | | |
|-----------------|--------|--------|-------|
| SAILOR LNFT PER | SqFt | 1.31 | 1.01 |
| | Layer | 14.78 | 10.39 |
| | Bundle | 118.22 | 83.15 |

| | | | |
|-----------|--------|-----|------|
| UNITS PER | SqFt | - | 0.58 |
| | Layer | 20 | 6 |
| | Bundle | 160 | 48 |

| | | | |
|---------|--------|-------|-------|
| LBS PER | Unit | - | 50 |
| | Layer | 309 | 301 |
| | Bundle | 2,472 | 2,411 |

| Colors | Reflectance | Stock | Stock |
|--------------|----------------|-------|-------|
| Dawn Mist | SR .37 SRI 41 | ✓ | ✓ |
| Pebble Taupe | SR .38 SRI 42 | ✓ | ✓ |
| Smoke Shale | SR n/a SRI n/a | ✓ | ✓ |

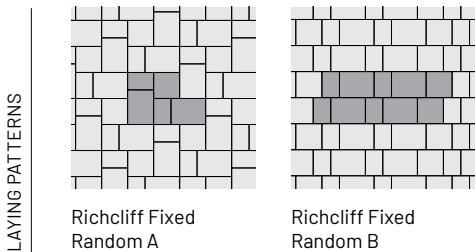
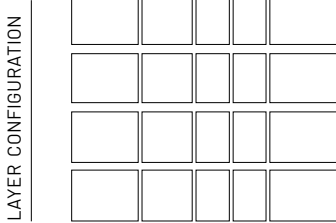

DAWN MIST



PEBBLE TAUPE

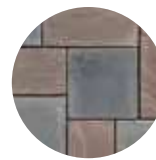

PEBBLE TAUPE
DAWN MIST
Blended on Site



SMOKE SHALE

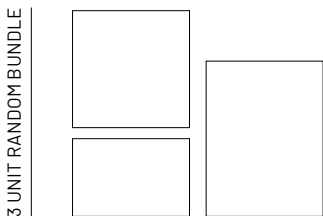

RECTANGLE
 226 x 300 x 60mm
 8 7/8 x 11 7/8 x 2 3/8"
 64 Units/Bundle
 .75 SqFt./Stone

SQUARE
 226 x 226 x 60mm
 8 7/8 x 8 7/8 x 2 3/8"
 32 Units/Bundle
 .58 Sq.Ft./Stone

SMALL RECTANGLE
 150 x 226 x 60mm
 5 7/8 x 8 7/8 x 2 3/8"
 64 Units/Bundle
 .38 Sq.Ft./Stone

SINGLE UNIT



LARGE RECTANGLE
 302 x 528 x 60mm
 11 7/8 x 20 7/8 x 2 3/8"
 48 Units/Bundle
 1.72 Sq.Ft./Stone

Notes: SOLD IN FULL BUNDLES ONLY and is produced and sold on a required, refundable skid. Important: A urethane rubber paver mat must be used to prevent scuffing when compacting. All measurements are nominal. Contact Unilock for more information.



APPLICATIONS

Pedestrian, Roof Deck

APPEARANCE

Edge Detail - Rounded
 Surface Texture - Smooth
 Joint Spacing - 2 mm

TECHNICAL INFORMATION

Conforms to ASTM C1782
 Eligible for LEED v4.1 credits

// Perfect for roof decks and other raised floor applications.

Ask us about our Skyview™ pedestal system.
 See page 84 for more information.

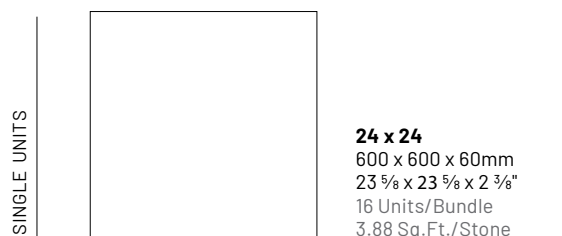
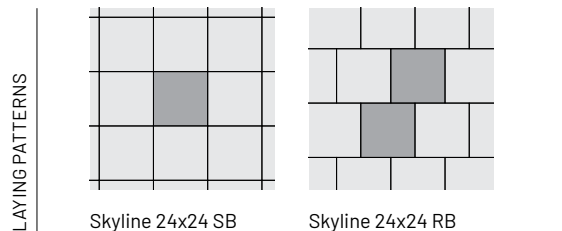
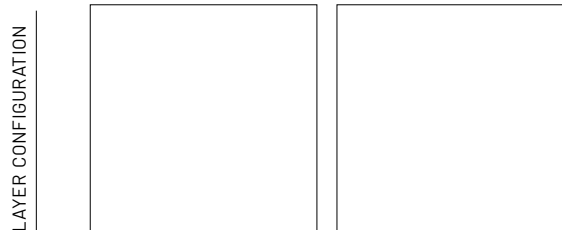

| | |
|----------------|----------|
| | 24 x 24 |
| Bundle Type | SINGLE |
| Plant Produced | NEW YORK |
| Thickness (mm) | 60 mm |

| | | |
|----------|--------|-------|
| SQFT PER | Stone | 3.88 |
| | Layer | 7.75 |
| | Bundle | 62.00 |

| | | |
|------------|--------|---|
| PER BUNDLE | Layers | 8 |
|------------|--------|---|

| | | |
|------------------|--------|---|
| SOLDIER LNFT PER | SqFt | - |
| | Layer | - |
| | Bundle | - |

| | | |
|-----------------|--------|---|
| SAILOR LNFT PER | SqFt | - |
| | Layer | - |
| | Bundle | - |

| | | |
|-----------|--------|------|
| UNITS PER | SqFt | 0.26 |
| | Layer | 2 |
| | Bundle | 16 |

| | | |
|---------|--------|-------|
| LBS PER | Unit | 106 |
| | Layer | 211 |
| | Bundle | 1,690 |

| Colors | Reflectance | Stock |
|------------------------------|-------------|-------|
| Multiple Colors and Finishes | N/A | ✓ |

Notes: Made-to-Order. Minimum quantities apply. Lead time required. SOLD IN FULL BUNDLES ONLY and is produced and sold on a required, refundable skid. Product is not intended vehicular applications. Unilock offers adjustable and stackable pedestal systems; please contact your Territory Manager for pricing and availability. All measurements are nominal.



APPLICATIONS

Pedestrian, Roof Deck

APPEARANCE

Edge Detail - Micro

Surface Texture - Thermal and Shot Blast

Joint Spacing - 0 mm

TECHNICAL INFORMATION

Conforms to ASTM C 1782

Eligible for LEED v4.1

// Perfect for roof decks and other raised floor applications.

Ask us about our Skyview™ pedestal system. See page 84 for more information.

| | |
|----------------|---------|
| | 16 x 32 |
| Bundle Type | SINGLE |
| Plant Produced | CHICAGO |
| Thickness (mm) | 50 mm |

| | | |
|----------|--------|-------|
| SQFT PER | Stone | 3.57 |
| | Layer | 3.57 |
| | Bundle | 64.27 |

| | | |
|------------|--------|----|
| PER BUNDLE | Layers | 18 |
|------------|--------|----|

| | | |
|------------------|--------|-------|
| SOLDIER LNFT PER | SqFt | 0.37 |
| | Layer | 1.34 |
| | Bundle | 24.04 |

| | | |
|-----------------|--------|-------|
| SAILOR LNFT PER | SqFt | 0.75 |
| | Layer | 2.67 |
| | Bundle | 48.13 |

| | | |
|-----------|--------|------|
| UNITS PER | SqFt | 0.28 |
| | Layer | 1 |
| | Bundle | 18 |

| | | |
|---------|--------|-------|
| LBS PER | Unit | 86 |
| | Layer | 86 |
| | Bundle | 1,549 |

| Colors | Reflectance | Stock |
|---------------|----------------|-------|
| Dark Charcoal | SR n/a SRI n/a | ✓ |
| Light Granite | SR .44 SRI 50 | ✓ |
| Toscana Beige | SR .64 SRI 77 | ✓ |

LAYING PATTERNS

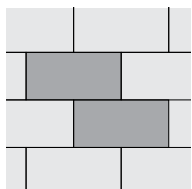

Soreno 16x32 RB

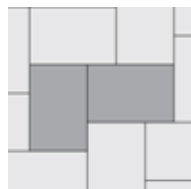

Soreno 16x32 HB

SINGLE UNITS

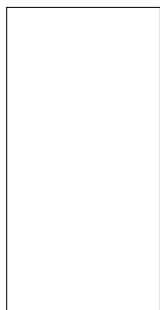

16 x 32
 407 x 815 x 50mm
 16 x 32 x 2"
 18 Units/Bundle
 3.57 Sq.Ft./Stone

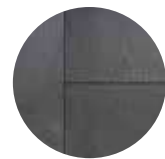

DARK CHARCOAL

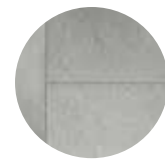

LIGHT GRANITE



TOSCANA BEIGE

Notes: **SOLD IN FULL BUNDLES ONLY** and is produced and sold on a required, refundable skid. This product is not intended for vehicular applications. Important: A urethane rubber paver mat must be used to prevent scuffing when compacting. All measurements are nominal. Contact Unilock for more information.



APPLICATIONS

Pedestrian, Light Vehicular, Roadway Street,
Border/Accents, Permeable

APPEARANCE

Edge Detail - Rounded
Surface Texture - Textured
Joint Spacing - 10 mm

TECHNICAL INFORMATION

Conforms to ASTM C 936
Eligible for LEED v4.1 credits

| | |
|----------------|----------|
| | STANDARD |
| Bundle Type | SINGLE |
| Plant Produced | ONTARIO |
| Thickness (mm) | 70 mm |

| | | |
|----------|--------|-------|
| SQFT PER | Stone | 0.28 |
| | Layer | 11.05 |
| | Bundle | 88.41 |

| | | |
|------------|--------|---|
| PER BUNDLE | Layers | 8 |
|------------|--------|---|

| | | |
|------------------|--------|--------|
| SOLDIER LNFT PER | SqFt | 1.19 |
| | Layer | 13.12 |
| | Bundle | 104.99 |

| | | |
|-----------------|--------|--------|
| SAILOR LNFT PER | SqFt | 2.97 |
| | Layer | 32.81 |
| | Bundle | 262.47 |

| | | |
|-----------|--------|------|
| UNITS PER | SqFt | 3.62 |
| | Layer | 40 |
| | Bundle | 320 |

| | | |
|---------|--------|-------|
| LBS PER | Unit | 9 |
| | Layer | 361 |
| | Bundle | 2,888 |

| Colors | Reflectance | Stock |
|--------------|----------------|-------|
| Basalt | SR n/a SRI n/a | ✓ |
| Burgundy Red | SR .35 SRI 38 | ✓ |
| Burnt Clay | SR .36 SRI 40 | ✓ |
| Old Oak | SR .37 SRI 41 | ✓ |



BASALT



BURGUNDY RED



BURNT CLAY



OLD OAK



3 COLOR BLEND
Blended on Site

LAYING PATTERNS

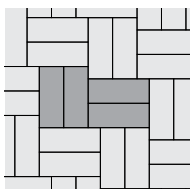

TownHall 4x10 DHB

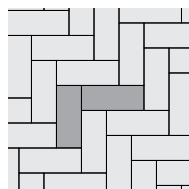

TownHall 4x10 HB

SINGLE UNIT



STANDARD
250 x 100 x 70mm
9 7/8 x 3 7/8 x 2 3/4"
320 Units/Bundle
.28 Sq.Ft./Stone

Notes: **SOLD IN FULL BUNDLES ONLY** and is produced and sold on a required, refundable skid. **Important: A urethane rubber paver mat must be used to prevent scuffing when compacting.** All measurements are nominal. Contact Unilock for more information.



| | | |
|----------------|---------------------|---------------------|
| | | SMALL RECTANGLE |
| Bundle Type | RANDOM | SINGLE |
| Plant Produced | NEW YORK / UXBRIDGE | NEW YORK / UXBRIDGE |
| Thickness (mm) | 60 mm | 60 mm |

| | | | |
|----------|--------|--------|--------|
| SQFT PER | Stone | - | 0.30 |
| | Layer | 11.89 | 11.89 |
| | Bundle | 118.90 | 118.90 |

| | | | |
|------------|--------|----|----|
| PER BUNDLE | Layers | 10 | 10 |
|------------|--------|----|----|

| | | | |
|------------------|--------|---|--------|
| SOLDIER LNFT PER | SqFt | - | 1.30 |
| | Layer | - | 15.42 |
| | Bundle | - | 154.20 |

| | | | |
|-----------------|--------|--------|--------|
| SAILOR LNFT PER | SqFt | 1.78 | 2.59 |
| | Layer | 21.19 | 30.84 |
| | Bundle | 211.90 | 308.40 |

| | | | |
|-----------|--------|-----|------|
| UNITS PER | SqFt | - | 3.36 |
| | Layer | 25 | 40 |
| | Bundle | 250 | 400 |

| | | | |
|---------|--------|-------|-------|
| LBS PER | Unit | - | 9 |
| | Layer | 344 | 349 |
| | Bundle | 3,435 | 3,485 |

| Colors | Reflectance | Stock | Stock |
|----------------|----------------|-------|-------|
| Almond Grove | SR .25 SRI 25 | ✓ | ✓ |
| Dark Charcoal | SR n/a SRI n/a | - | ✓ |
| Fossil | SR .22 SRI 21 | ✓ | ✓ |
| Granite Fusion | SR .30 SRI 31 | ✓ | ✓ |
| Sierra | SR n/a SRI n/a | ✓ | - |
| Tuscany | SR .30 SRI 32 | ✓ | ✓ |
| Walnut | SR n/a SRI n/a | ✓ | - |

APPLICATIONS

Pedestrian, Light Vehicular, Border/Accents

APPEARANCE

Edge Detail - Rounded

Surface Texture - Textured

Joint Spacing - 4 mm

TECHNICAL INFORMATION

Conforms to ASTM C 936

Eligible for LEED v4.1 credits

LAYER CONFIGURATION

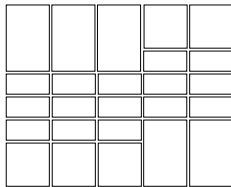

LAYING PATTERNS

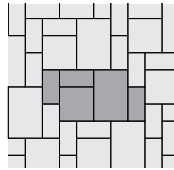
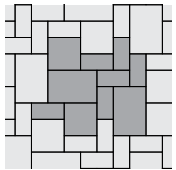

Treo Fixed Random_C

Treo Fixed Random_D

SINGLE UNIT



SMALL RECTANGLE

117.5 x 235 x 60mm
4 5/8 x 9 1/2 x 2 3/8"
400 Units/Bundle
.30 Sq.Ft./Stone

RANDOM BUNDLE

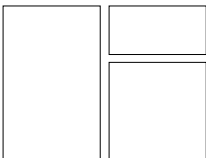

LARGE RECTANGLE

235 x 352.5 x 60mm
9 1/2 x 13 7/8 x 2 3/8"
50 Units/Bundle
.89 Sq.Ft./Stone

SQUARE

235 x 235 x 60mm
9 1/2 x 9 1/2 x 2 3/8"
50 Units/Bundle
.59 Sq.Ft./Stone

SMALL RECTANGLE

117.5 x 235 x 60mm
4 5/8 x 9 1/2 x 2 3/8"
150 Units/Bundle
.30 Sq.Ft./Stone



ALMOND GROVE



DARK CHARCOAL
(Small Rec Only)



FOSSIL

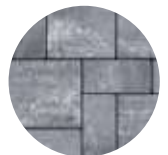

GRANITE FUSION

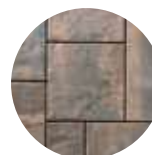

SIERRA

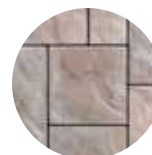

TUSCANY



WALNUT

Notes: **SOLD IN FULL BUNDLES ONLY** and is produced and sold on a required, refundable skid. **Important: A urethane rubber paver mat must be used to prevent scuffing when compacting on textured surfaces.** All measurements are nominal. Contact Unilock for more information.



APPLICATIONS

Pedestrian, Light Vehicular, Permeable

APPEARANCE

Edge Detail - Rounded
Surface Texture - Smooth
Joint Spacing - 7 mm

TECHNICAL INFORMATION

Conforms to ASTM C 936
Eligible for LEED v4.1 credits

| | | |
|----------------|---------------------|-----------------|
| | | SMALL RECTANGLE |
| Bundle Type | RANDOM | SINGLE |
| Plant Produced | NEW YORK / UXBRIDGE | UXBRIDGE |
| Thickness (mm) | 60 mm | 60 mm |

| | | | |
|----------|--------|--------|--------|
| SQFT PER | Stone | - | 0.29 |
| | Layer | 11.69 | 11.69 |
| | Bundle | 116.87 | 116.87 |

| | | | |
|------------|--------|----|----|
| PER BUNDLE | Layers | 10 | 10 |
|------------|--------|----|----|

| | | | |
|------------------|--------|---|--------|
| SOLDIER LNFT PER | SqFt | - | 1.31 |
| | Layer | - | 15.29 |
| | Bundle | - | 152.89 |

| | | | |
|-----------------|--------|--------|--------|
| SAILOR LNFT PER | SqFt | 1.57 | 2.62 |
| | Layer | 18.35 | 30.58 |
| | Bundle | 183.46 | 305.77 |

| | | | |
|-----------|--------|-----|------|
| UNITS PER | SqFt | - | 3.42 |
| | Layer | 21 | 40 |
| | Bundle | 210 | 400 |

| | | | |
|---------|--------|-------|-------|
| LBS PER | Unit | - | 8 |
| | Layer | 321 | 321 |
| | Bundle | 3,208 | 3,208 |

| Colors | Reflectance | Stock | Stock |
|----------------|----------------|-------|-------|
| Almond Grove | SR .25 SRI 25 | ✓ | ✓ |
| Fossil | SR .22 SRI 21 | ✓ | ✓ |
| Granite Fusion | SR .30 SRI 31 | ✓ | ✓ |
| Slate | SR n/a SRI n/a | ✓ | - |
| Dark Charcoal | SR n/a SRI n/a | - | ✓ |

LAYER CONFIGURATION

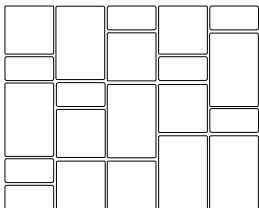

LAYING PATTERNS

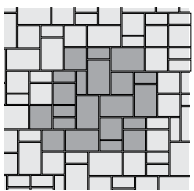

Treo Fixed Random R

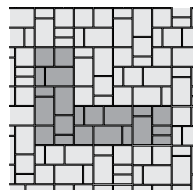

Treo Fixed Random S

SINGLE UNIT

SMALL RECTANGLE

116.5 x 233 x 60mm
4 5/8 x 9 1/4 x 2 3/8"
400 Units/Bundle
.29 Sq.Ft./Stone



RANDOM BUNDLE



LARGE RECTANGLE

233 x 349.5 x 60mm
9 1/4 x 13 3/4 x 2 3/8"
60 Units/Bundle
.88 Sq.Ft./Stone

SQUARE

233 x 233 x 60mm
9 1/4 x 9 1/4 x 2 3/8"
70 Units/Bundle
.58 Sq.Ft./Stone

SMALL RECTANGLE

116.5 x 233 x 60mm
4 5/8 x 9 1/4 x 2 3/8"
80 Units/Bundle
.29 Sq.Ft./Stone



ALMOND GROVE



FOSSIL

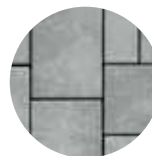

SLATE



GRANITE FUSION



DARK CHARCOAL
(Small Rec Only)

Notes: SOLD IN FULL BUNDLES ONLY and is produced and sold on a required, refundable skid. Important: A urethane rubber paver mat must be used to prevent scuffing when compacting on textured surfaces. All measurements are nominal. Contact Unilock for more information.

NEW



APPLICATIONS

Pedestrian, Light Vehicular, Permeable

APPEARANCE

Edge Detail - Rounded
 Surface Texture - Smooth
 Joint Spacing - 7 mm

TECHNICAL INFORMATION

Conforms to ASTM C 936
 Eligible for LEED v4.1 credits

| | |
|----------------|----------|
| Bundle Type | RANDOM |
| Plant Produced | UXBRIDGE |
| Thickness (mm) | 60 mm |

| | | |
|----------|--------|--------|
| SQFT PER | Stone | - |
| | Layer | 116.69 |
| | Bundle | 116.87 |

| | | |
|------------|--------|----|
| PER BUNDLE | Layers | 10 |
|------------|--------|----|

| | | |
|------------------|--------|---|
| SOLDIER LNFT PER | SqFt | - |
| | Layer | - |
| | Bundle | - |

| | | |
|-----------------|--------|--------|
| SAILOR LNFT PER | SqFt | 1.57 |
| | Layer | 18.35 |
| | Bundle | 183.46 |

| | | |
|-----------|--------|-----|
| UNITS PER | SqFt | - |
| | Layer | 21 |
| | Bundle | 210 |

| | | |
|---------|--------|-------|
| LBS PER | Unit | - |
| | Layer | 321 |
| | Bundle | 3,208 |

| Colors | Reflectance | Stock |
|----------------|---------------|-------|
| Almond Grove | SR .25 SRI 25 | ✓ |
| Granite Fusion | SR .30 SRI 31 | ✓ |

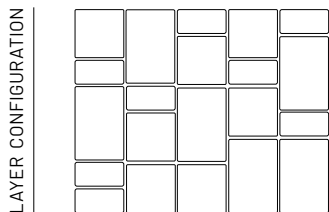

ALMOND GROVE



GRANITE FUSION

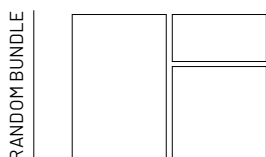

LARGE RECTANGLE
 233 x 349.5 x 60mm
 9 1/4 x 13 3/4 x 2 3/8"
 60 Units/Bundle
 .88 Sq.Ft./Stone

SQUARE
 233 x 233 x 60mm
 9 1/4 x 9 1/4 x 2 3/8"
 70 Units/Bundle
 .58 Sq.Ft./Stone

SMALL RECTANGLE
 116.5 x 233 x 60mm
 4 5/8 x 9 1/4 x 2 3/8"
 80 Units/Bundle
 .29 Sq.Ft./Stone

Notes: SOLD IN FULL BUNDLES ONLY and is produced and sold on a required, refundable skid. Important: A urethane rubber paver mat must be used to prevent scuffing when compacting on textured surfaces. All measurements are nominal. Contact Unilock for more information.



APPLICATIONS

Pedestrian, Light Vehicular, Permeable, Roadway Street

APPEARANCE

Edge Detail - Micro

Surface Texture - Series Exposed Finish

Joint Spacing - 10 mm

TECHNICAL INFORMATION

Conforms to ASTM C 936

Eligible for LEED v4.1 credits

| | | |
|----------------|----------|----------|
| | CURB | |
| Bundle Type | SINGLE | RANDOM |
| Plant Produced | NEW YORK | NEW YORK |
| Thickness (mm) | 180 mm | 70 mm |

| | | | |
|----------|--------|---|-------|
| SQFT PER | Stone | - | - |
| | Layer | - | 12.19 |
| | Bundle | - | 97.53 |

| | | | |
|------------|--------|---|---|
| PER BUNDLE | Layers | 3 | 8 |
|------------|--------|---|---|

| | | | |
|------------------|--------|-------|---|
| SOLDIER LNFT PER | SqFt | - | - |
| | Layer | 12.24 | - |
| | Bundle | 36.72 | - |

| | | | |
|-----------------|--------|---|--------|
| SAILOR LNFT PER | SqFt | - | 2.34 |
| | Layer | - | 28.49 |
| | Bundle | - | 227.95 |

| | | | |
|-----------|--------|----|-----|
| UNITS PER | SqFt | - | - |
| | Layer | 12 | 38 |
| | Bundle | 36 | 304 |

| | | | |
|---------|--------|-------|-------|
| LBS PER | Unit | 46 | - |
| | Layer | 555 | 398 |
| | Bundle | 1,664 | 3,186 |

| Colors | Reflectance | Stock | Stock |
|--------------------|----------------|-------|-------|
| Crystalline Basalt | SR n/a SRI n/a | ✓ | ✓ |
| Peppered Granite | SR .38 SRI 42 | ✓ | ✓ |

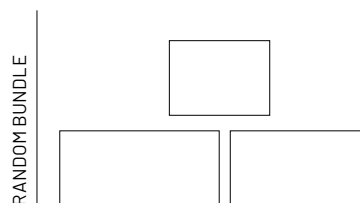
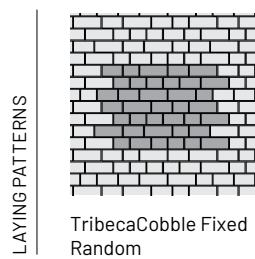
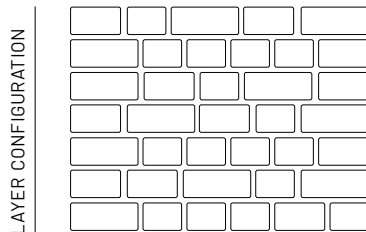

LARGE RECTANGLE
130 x 305 x 70mm
5 x 12 x 2 ¾"
88 Units/Bundle
.43 Sq.Ft./Stone

RECTANGLE
130 x 230 x 70mm
5 x 9 x 2 ¾"
88 Units/Bundle
.32 Sq.Ft./Stone

SMALL RECTANGLE
130 x 175 x 70mm
5 x 6 7/8 x 2 ¾"
128 Units/Bundle
.25 Sq.Ft./Stone

SINGLE UNIT

CURB
230 x 290 x 180mm
9 x 11 ½ x 7"
36 Units/Bundle

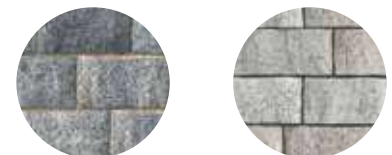

CRYSTALLINE BASALT PEPPERED GRANITE

Notes: SOLD IN FULL BUNDLES ONLY and is produced and sold on a required, refundable skid. Important: A urethane rubber paver mat must be used to prevent scuffing when compacting on textured surfaces. For permeable installations, Unilock recommends using granite chips for joint filler. All measurements are nominal. Contact Unilock for more information.



APPLICATIONS

Pedestrian, Light Vehicular, Permeable, Roadway Street

APPEARANCE

Edge Detail - Micro
Surface Texture - Textured
Joint Spacing - 10 mm

TECHNICAL INFORMATION

Conforms to ASTM C 936
Eligible for LEED v4.1 credits

| | |
|----------------|----------|
| Bundle Type | RANDOM |
| Plant Produced | NEW YORK |
| Thickness (mm) | 70 mm |

| | | |
|----------|--------|-------|
| SQFT PER | Stone | - |
| | Layer | 12.19 |
| | Bundle | 97.53 |

| | | |
|------------|--------|---|
| PER BUNDLE | Layers | 8 |
|------------|--------|---|

| | | |
|------------------|--------|---|
| SOLDIER LNFT PER | SqFt | - |
| | Layer | - |
| | Bundle | - |

| | | |
|-----------------|--------|--------|
| SAILOR LNFT PER | SqFt | 2.34 |
| | Layer | 28.49 |
| | Bundle | 227.95 |

| | | |
|-----------|--------|------|
| UNITS PER | SqFt | 3.12 |
| | Layer | 38 |
| | Bundle | 304 |

| | | |
|---------|--------|-------|
| LBS PER | Unit | 10 |
| | Layer | 398 |
| | Bundle | 3,186 |

| Colors | Reflectance | Stock |
|----------------|----------------|-------|
| Fossil | SR n/a SRI n/a | ✓ |
| Granite Fusion | SR n/a SRI n/a | ✓ |
| Dark Charcoal | SR n/a SRI n/a | ✓ |

LAYER CONFIGURATION

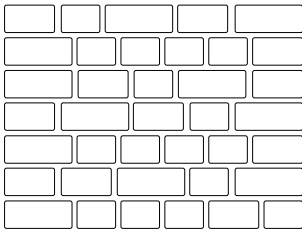

LAYING PATTERNS

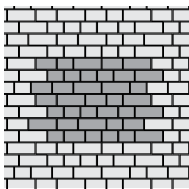

TribecaCobble Fixed Random

RANDOM BUNDLE

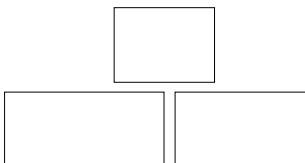

LARGE RECTANGLE
130 x 305 x 70mm
5 x 12 x 2 3/4"
88 Units/Bundle
.43 Sq.Ft./Stone

RECTANGLE
130 x 230 x 70mm
5 x 9 x 2 3/4"
88 Units/Bundle
.32 Sq.Ft./Stone

SMALL RECTANGLE
130 x 175 x 70mm
5 x 6 7/8 x 2 3/4"
128 Units/Bundle
.25 Sq.Ft./Stone

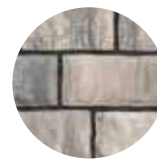

FOSSIL



GRANITE FUSION



DARK CHARCOAL

Notes: SOLD IN FULL BUNDLES ONLY and is produced and sold on a required, refundable skid. **Important: A urethane rubber paver mat must be used to prevent scuffing when compacting on textured surfaces.** For permeable installations, Unilock recommends using granite chips for joint filler. All measurements are nominal. Contact Unilock for more information.



APPLICATIONS

Pedestrian, Light Vehicular, Permeable,
Roadway Street

APPEARANCE

Edge Detail - Zero
Surface Texture - Smooth
Joint Spacing - 2 mm

TECHNICAL INFORMATION

Conforms to ASTM C1319
Eligible for LEED v4.1 credits

| | |
|----------------|----------|
| Bundle Type | SINGLE |
| Plant Produced | NEW YORK |
| Thickness (mm) | 80 mm |

| | | |
|----------|--------|-------|
| SQFT PER | Stone | 2.57 |
| | Layer | 10.29 |
| | Bundle | 72.00 |

| | | |
|------------|--------|---|
| PER BUNDLE | Layers | 7 |
|------------|--------|---|

| | | |
|------------------|--------|---|
| SOLDIER LNFT PER | SqFt | - |
| | Layer | - |
| | Bundle | - |

| | | |
|-----------------|--------|---|
| SAILOR LNFT PER | SqFt | - |
| | Layer | - |
| | Bundle | - |

| | | |
|-----------|--------|------|
| UNITS PER | SqFt | 0.39 |
| | Layer | 4 |
| | Bundle | 28 |

| | | |
|---------|--------|-------|
| LBS PER | Unit | 62 |
| | Layer | 250 |
| | Bundle | 1,748 |

| Colors | Reflectance | Stock |
|---------|---------------|-------|
| Natural | SR .30 SRI 32 | ✓ |

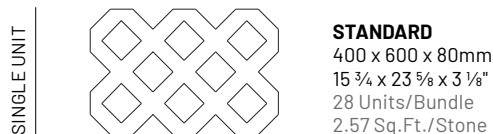
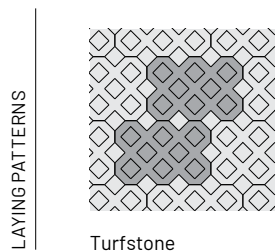
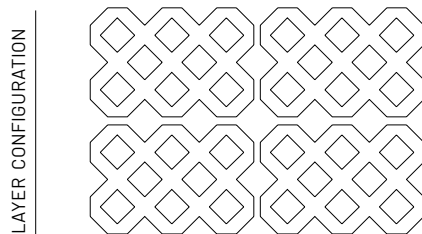

NATURAL

Notes: **SOLD IN FULL BUNDLES ONLY** and is produced and sold on a required, refundable skid. All measurements are nominal. Contact Unilock for more information.



APPLICATIONS

Pedestrian, Roof Deck

APPEARANCE

Edge Detail - Rounded

Surface Texture - Umbriano Mottled

Joint Spacing - 4 mm

TECHNICAL INFORMATION

Conforms to ASTM C 936

Eligible for LEED v4.1 credits

// Perfect for roof decks and other raised floor applications.

Ask us about our Skyview™ pedestal system.
See page 84 for more information.

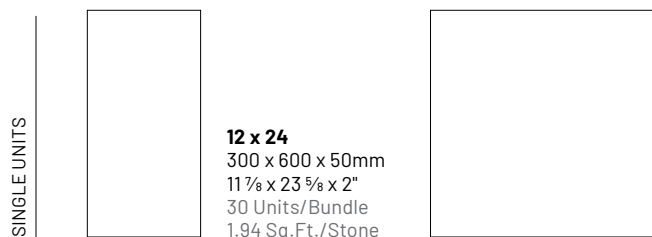
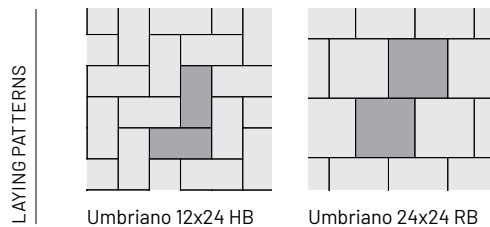
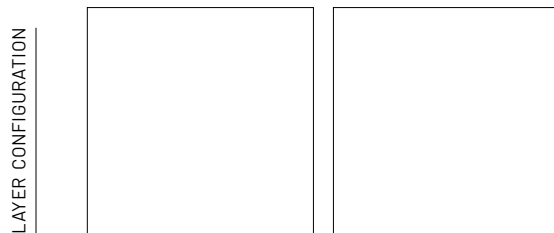

| | | | |
|--|----------------|---------|---------|
| | | 12 x 24 | 24 x 24 |
| | Bundle Type | SINGLE | SINGLE |
| | Plant Produced | ONTARIO | ONTARIO |
| | Thickness (mm) | 50 mm | 50 mm |

| | | | |
|----------|--------|-------|-------|
| SQFT PER | Stone | 1.94 | 3.88 |
| | Layer | 11.63 | 7.75 |
| | Bundle | 58.13 | 38.75 |

| | | | |
|------------|--------|---|---|
| PER BUNDLE | Layers | 5 | 5 |
|------------|--------|---|---|

| | | | |
|------------------|--------|-------|-------|
| SOLDIER LNFT PER | SqFt | 0.51 | 0.51 |
| | Layer | 5.91 | 3.94 |
| | Bundle | 29.53 | 19.68 |

| | | | |
|-----------------|--------|-------|-------|
| SAILOR LNFT PER | SqFt | 1.02 | 0.51 |
| | Layer | 11.81 | 3.49 |
| | Bundle | 59.06 | 19.68 |

| | | | |
|-----------|--------|------|------|
| UNITS PER | SqFt | 0.52 | 0.26 |
| | Layer | 6 | 2 |
| | Bundle | 30 | 10 |

| | | | |
|---------|--------|-------|-----|
| LBS PER | Unit | 43 | 87 |
| | Layer | 261 | 175 |
| | Bundle | 1,303 | 874 |

| Colors | Reflectance | Stock | Stock |
|---------------|---------------|-------|-------|
| French Grey | SR .18 SRI 17 | SO | SO |
| Grenada White | SR .45 SRI 52 | SO | SO |

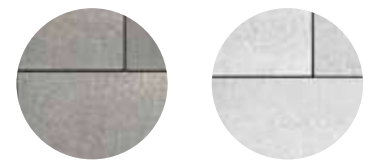

FRENCH GREY

GRENADA WHITE

Notes: Special Order. Lead time required. SOLD IN FULL BUNDLES ONLY and is produced and sold on a required, refundable skid. **Important: A urethane rubber paver mat must be used to prevent scuffing when compacting on textured surfaces. This product is not intended for vehicular use.** All measurements are nominal. Contact Unilock for more information.



APPLICATIONS

Pedestrian

APPEARANCE

Edge Detail - Micro

Surface Texture - Umbriano Mottled

Joint Spacing - 4 mm

TECHNICAL INFORMATION

Conforms to ASTM C 936

Eligible for LEED v4.1 credits

// 80mm Drive friendly available as special order. See page 50

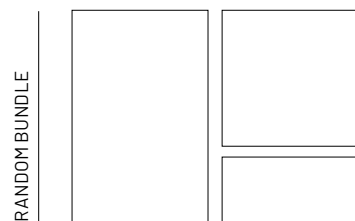
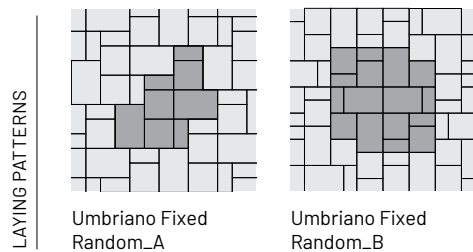
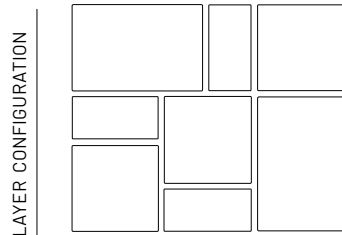

LARGE RECTANGLE
360 x 540 x 60mm
14 1/4 x 21 1/4 x 2 3/8"
20 Units/Bundle
2.09 Sq.Ft./Stone

SQUARE
360 x 360 x 60mm
14 1/4 x 14 1/4 x 2 3/8"
30 Units/Bundle
1.40 Sq.Ft./Stone

SMALL RECTANGLE
180 x 360 x 60mm
7 x 14 1/4 x 2 3/8"
30 Units/Bundle
.70 Sq.Ft./Stone

| | |
|----------------|----------|
| Bundle Type | RANDOM |
| Plant Produced | NEW YORK |
| Thickness (mm) | 60 mm |

| | | |
|----------|--------|--------|
| SQFT PER | Stone | - |
| | Layer | 10.46 |
| | Bundle | 104.60 |

| | | |
|------------|--------|----|
| PER BUNDLE | Layers | 10 |
|------------|--------|----|

| | | |
|------------------|--------|---|
| SOLDIER LNFT PER | SqFt | - |
| | Layer | - |
| | Bundle | - |

| | | |
|-----------------|--------|-------|
| SAILOR LNFT PER | SqFt | 0.82 |
| | Layer | 8.61 |
| | Bundle | 86.12 |

| | | |
|-----------|--------|----|
| UNITS PER | SqFt | - |
| | Layer | 8 |
| | Bundle | 80 |

| | | |
|---------|--------|-------|
| LBS PER | Unit | - |
| | Layer | 305 |
| | Bundle | 3,050 |

| Colors | Reflectance | Stock |
|---------------|---------------|-------|
| French Grey | SR .18 SRI 17 | ✓ |
| Grenada White | SR .45 SRI 52 | ✓ |
| Midnight Sky | SR .17 SRI 15 | ✓ |
| Summer Wheat | SR .42 SRI 48 | ✓ |
| Winter Marvel | SR .35 SRI 38 | ✓ |

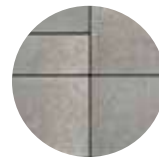

FRENCH GREY

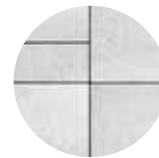

GRENADA WHITE

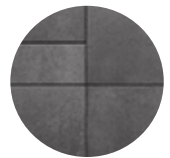

MIDNIGHT SKY



SUMMER WHEAT

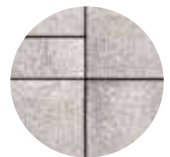

WINTER MARVEL

Notes: **SOLD IN FULL BUNDLES ONLY** and is produced and sold on a required, refundable skid. **Important: A urethane rubber paver mat must be used to prevent scuffing when compacting on textured surfaces. This product is not intended for vehicular use.**
All measurements are nominal. Contact Unilock for more information.



APPLICATIONS

Pedestrian, Light Vehicular, Roadway Street,
Heavy-duty, Permeable

APPEARANCE

Edge Detail - Zero
Surface Texture - Umbriano Mottled
Joint Spacing - 4 mm

TECHNICAL INFORMATION

Conforms to ASTM C 936
Eligible for LEED v4.1 credits

| | | |
|----------------|---------|---------------------|
| | | 4 X 12 PERMEABLE |
| Bundle Type | RANDOM | SINGLE |
| Plant Produced | ONTARIO | ONTARIO |
| Thickness (mm) | 80 mm | 80 mm |

| | | | |
|----------|--------|-------|-------|
| SQFT PER | Stone | - | 0.32 |
| | Layer | 10.46 | 11.63 |
| | Bundle | 73.22 | 93.04 |

| | | | |
|------------|--------|---|---|
| PER BUNDLE | Layers | 7 | 8 |
|------------|--------|---|---|

| | | | |
|------------------|--------|---|-------|
| SOLDIER LNFT PER | SqFt | - | 1.02 |
| | Layer | - | 11.81 |
| | Bundle | - | 94.49 |

| | | | |
|-----------------|--------|-------|--------|
| SAILOR LNFT PER | SqFt | 0.85 | 3.10 |
| | Layer | 8.86 | 35.43 |
| | Bundle | 62.01 | 283.46 |

| | | | |
|-----------|--------|------|------|
| UNITS PER | SqFt | 0.76 | 3.10 |
| | Layer | 8 | - |
| | Bundle | 56 | 288 |

| | | | |
|---------|--------|-------|-------|
| LBS PER | Unit | 48 | - |
| | Layer | 383 | 426 |
| | Bundle | 2,680 | 3,404 |

| Colors | Reflectance | Stock | Stock |
|---------------|---------------|-------|-------|
| Summer Wheat | SR .42 SRI 48 | SO | - |
| Winter Marvel | SR .35 SRI 38 | SO | SO |
| French Grey | SR .18 SRI 17 | - | SO |
| Midnight Sky | SR .17 SRI 15 | - | SO |

LAYER CONFIGURATION

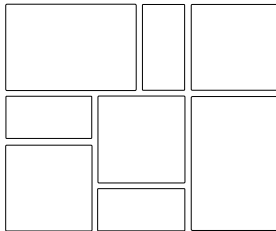

LAYING PATTERNS

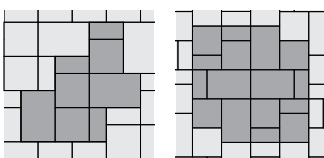

Umbriano Fixed
Random A

Umbriano Fixed
Random B

RANDOM BUNDLE

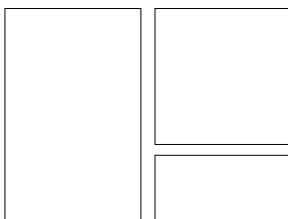

LARGE RECTANGLE
360 x 540 x 80mm
14 x 21 x 3 1/8"
14 Units/Bundle
2.09 Sq.Ft./Stone

SQUARE
360 x 360 x 80mm
14 x 14 x 3 1/8"
21 Units/Bundle
1.40 Sq.Ft./Stone

SMALL RECTANGLE
180 x 360 x 80mm
7 x 14 1/4 x 3 1/8"
21 Units/Bundle
0.70 Sq.Ft./Stone

SINGLE UNITS

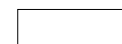

4 x 12 PERMEABLE
100 x 300 x 80mm
3 3/8 x 11 3/8 x 3 1/8"
288 Units/Bundle
0.70 Sq.Ft./Stone

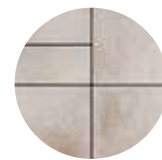

SUMMER WHEAT

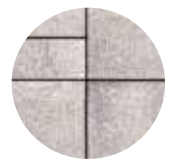

WINTER MARVEL



FRENCH GREY

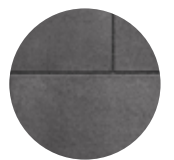

MIDNIGHT SKY

Notes: Special Order. Lead time required. SOLD IN FULL BUNDLES ONLY and is produced and sold on a required, refundable skid. Important: A urethane rubber paver mat must be used to prevent scuffing when compacting on textured surfaces. All measurements are nominal. Contact Unilock for more information.



APPLICATIONS

Pedestrian, Roof Deck

APPEARANCE

Edge Detail - Rounded
 Surface Texture - Smooth
 Joint Spacing - 4 mm

TECHNICAL INFORMATION

Conforms to ASTM C 936
 Eligible for LEED v4.1 credits

// Perfect for roof decks and other raised floor applications.

Ask us about our Skyview™ pedestal system.
 See page 84 for more information.

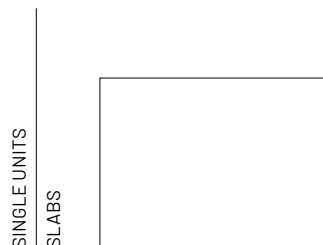
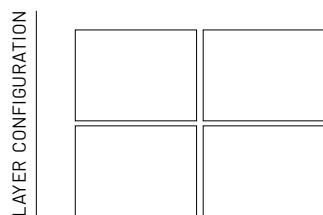

18 x 24
 450x 600 x 60mm
 17 ¾ x 23 ⅝ x 2 ⅜"
 32 Units/Bundle
 2.91 Sq.Ft./Stone

| | |
|----------------|----------|
| | 18 x 24 |
| Bundle Type | SINGLE |
| Plant Produced | UXBRIDGE |
| Thickness (mm) | 60 mm |

| | | |
|----------|--------|-------|
| SQFT PER | Stone | 2.91 |
| | Layer | 11.63 |
| | Bundle | 93.00 |

| | | |
|------------|--------|---|
| PER BUNDLE | Layers | 8 |
|------------|--------|---|

| | | |
|------------------|--------|-------|
| SOLDIER LNFT PER | SqFt | 0.51 |
| | Layer | 5.91 |
| | Bundle | 47.25 |

| | | |
|-----------------|--------|-------|
| SAILOR LNFT PER | SqFt | 0.68 |
| | Layer | 7.87 |
| | Bundle | 62.99 |

| | | |
|-----------|--------|------|
| UNITS PER | SqFt | 0.34 |
| | Layer | 4 |
| | Bundle | 32 |

| | | |
|---------|--------|-------|
| LBS PER | Unit | 80 |
| | Layer | 319 |
| | Bundle | 2,552 |

| Colors | Reflectance | Stock |
|----------------|-----------------|-------|
| Indiana Buff | SR .n/a SRI n/a | ✓ |
| Fossil | SR .n/a SRI n/a | ✓ |
| Granite Fusion | SR .n/a SRI n/a | ✓ |
| Platinum | SR .n/a SRI n/a | ✓ |
| Sterling | SR .n/a SRI n/a | ✓ |
| Tuscany | SR .n/a SRI n/a | ✓ |



Notes: SOLD IN FULL BUNDLES ONLY and is produced and sold on a required, refundable skid. **Important: A urethane rubber paver mat must be used to prevent scuffing when compacting on textured surfaces.** All measurements are nominal. Contact Unilock for more information.



APPLICATIONS

Pedestrian, Light Vehicular, Border/Accents

APPEARANCE

Edge Detail - Zero

Surface Texture - Textured

Joint Spacing - 3-7mm

TECHNICAL INFORMATION

Conforms to ASTM C 936

Eligible for LEED v4.1 credits

| | | |
|----------------|----------|----------|
| | | 5 x 10 |
| Bundle Type | RANDOM | SINGLE |
| Plant Produced | UXBRIDGE | UXBRIDGE |
| Thickness (mm) | 70 mm | 70 mm |

| | | | |
|----------|--------|-------|-------|
| SQFT PER | Stone | - | 0.34 |
| | Layer | 11.77 | 11.77 |
| | Bundle | 94.19 | 94.19 |

| | | | |
|------------|--------|---|---|
| PER BUNDLE | Layers | 8 | 8 |
|------------|--------|---|---|

| | | | |
|------------------|--------|---|--------|
| SOLDIER LNFT PER | SqFt | - | 1.24 |
| | Layer | - | 14.58 |
| | Bundle | - | 116.64 |

| | | | |
|-----------------|--------|--------|--------|
| SAILOR LNFT PER | SqFt | 1.24 | 2.48 |
| | Layer | 14.57 | 29.16 |
| | Bundle | 116.56 | 233.28 |

| | | | |
|-----------|--------|-----|------|
| UNITS PER | SqFt | - | 2.97 |
| | Layer | 20 | 35 |
| | Bundle | 160 | 280 |

| | | | |
|---------|--------|-------|-------|
| LBS PER | Unit | - | 11 |
| | Layer | 373 | 373 |
| | Bundle | 2,985 | 2,985 |

| Colors | Reflectance | Stock | Stock |
|----------------|----------------|-------|-------|
| Dark Charcoal | SR.n/a SRI n/a | - | ✓ |
| Fossil | SR n/a SRI n/a | ✓ | ✓ |
| Steel Mountain | SR n/a SRI n/a | ✓ | ✓ |
| Walnut | SR n/a SRI n/a | ✓ | ✓ |

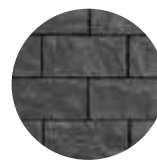
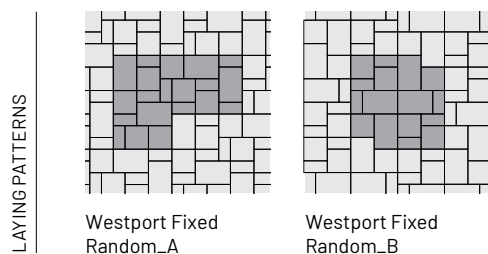
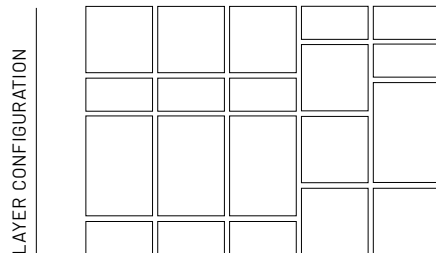

DARK CHARCOAL
(5 x 10 Only)

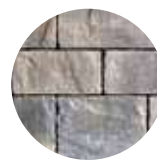

FOSSIL

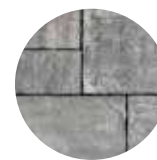

STEEL MOUNTAIN



WALNUT

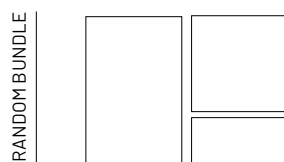

LARGE RECTANGLE
254 x 380 x 70mm
10 x 15 x 2 3/4"
32 Units/Bundle
1.04 Sq.Ft./Stone

SQUARE
254 x 254 x 70mm
10 x 10 x 2 3/4"
56 Units/Bundle
.69 Sq.Ft./Stone

RECTANGLE
127 x 254 x 70mm
5 x 10 x 2 3/4"
72 Units/Bundle
.34 Sq.Ft./Stone

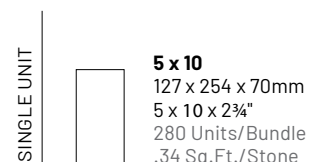

Notes: **SOLD IN FULL BUNDLES ONLY** and is produced and sold on a required, refundable skid. **Important: A urethane rubber paver mat must be used to prevent scuffing when compacting on textured surfaces.** All measurements are nominal. Contact Unilock for more information.

Brussels Dimensional Stone®



APPLICATIONS

Garden Wall, Seat Wall, Outdoor Kitchen, Fire Feature, Water Feature

APPEARANCE

Surface Texture - Antiqued

CROSS SECTIONS

Cross Sections are available on Unilock's Contractor website under Products: contractor.unilock.com

TECHNICAL INFORMATION

Conforms to ASTM C 1372
Eligible for LEED v4.1

| | |
|----------------|----------|
| | STANDARD |
| Bundle Type | SINGLE |
| Plant Produced | UXBRIDGE |
| Thickness (mm) | 100 mm |

| | | |
|----------|--------|-------|
| FCFT PER | Stone | 0.33 |
| | Layer | 6.00 |
| | Bundle | 36.00 |

| | | |
|------------|--------|---|
| PER BUNDLE | Layers | 6 |
|------------|--------|---|

| | | |
|----------|--------|------|
| LNFT PER | Unit | 1.00 |
| | Bundle | 108 |

| | | |
|-----------|--------|------|
| UNITS PER | SqFt | 3.00 |
| | Layer | 18 |
| | Bundle | 108 |

| | | |
|---------|--------|-------|
| LBS PER | Units | 30 |
| | Layer | 546 |
| | Bundle | 3,274 |

| Colors | Reflectance | Stock |
|-----------|----------------|-------|
| Sandstone | SR n/a SRI n/a | ✓ |
| Limestone | SR n/a SRI n/a | ✓ |
| Sierra | SR n/a SRI n/a | ✓ |



SANDSTONE



LIMESTONE



SIERRA

SINGLE UNIT



STANDARD
300 x 200 x 100 mm
11 7/8 x 7 7/8 x 3 7/8"
108 Units/Bundle
.33 Fc.Ft./Stone

SUNSET FIRE PIT KITS

Located on page 84



ROUND



SQUARE

Notes: Maximum height is 24" (under optimum conditions). Based on an 8" deep wall coverage = 36 sqft. per bundle. *Based on 12" deep wall coverage = 24 sqft. per bundle. All measurements are nominal. Contact Unilock for more information.

Concord Wall™



APPLICATIONS

Garden Wall, Structural Wall

APPEARANCE

Surface Texture - Split

CROSS SECTIONS

Cross Sections are available on Unilock's Contractor website under Products: contractor.unilock.com

TECHNICAL INFORMATION

Conforms to ASTM C 1372

Eligible for LEED v4.1 credits

| | CORNER | XL UNIT | COPING / STEP TREAD | WEDGE CAP UNIT |
|----------------|----------|----------|---------------------|----------------|
| Bundle Type | SINGLE | SINGLE | SINGLE | SINGLE |
| Plant Produced | UXBRIDGE | UXBRIDGE | UXBRIDGE | UXBRIDGE |
| Thickness (mm) | 150 mm | 150 mm | 75 mm | 75 mm |

| FCFT PER | Stone | 0.83 | 0.67 | 1.94 | 0.17 |
|----------|--------|-------|-------|-------|-------|
| | Layer | 5.00 | 5.33 | 3.88 | 2.08 |
| | Bundle | 15.00 | 21.33 | 31.00 | 16.66 |

| PER BUNDLE | Layers | 3 | 4 | 8 | 8 |
|------------|--------|---|---|---|---|
|------------|--------|---|---|---|---|

| LNFT PER | Unit | - | - | 4.00 | 0.66 |
|----------|--------|---|---|-------|-------|
| | Bundle | - | - | 64.00 | 63.39 |

| UNITS PER | SqFt | 1.20 | 1.50 | 1.63 | 5.88 |
|-----------|--------|------|------|------|------|
| | Layer | 6 | 8 | 2 | 12 |
| | Bundle | 18 | 32 | 16 | 96 |

| LBS PER | Units | 46 | 77 | 145 | 27 |
|---------|--------|-----|-------|-------|-------|
| | Layer | 273 | 614 | 290 | 318 |
| | Bundle | 820 | 2,455 | 2,320 | 2,544 |

| Colors | Reflectance | Stock | Stock | Stock | Stock |
|--------------|----------------|-------|-------|-------|-------|
| Almond Grove | SR n/a SRI n/a | ✓ | ✓ | ✓ | ✓ |
| Granite | SR n/a SRI n/a | ✓ | ✓ | ✓ | ✓ |
| Sierra | SR n/a SRI n/a | ✓ | ✓ | ✓ | ✓ |



ALMOND GROVE



GRANITE



SIERRA

SINGLE UNITS

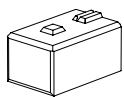

CORNER
200 x 300 x 150 mm
7 7/8 x 11 7/8 x 5 7/8"
18 Units/Bundle
.81 Fc.Ft./Stone

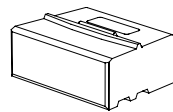

XL UNIT
400 x 300 x 150 mm
15 3/4 x 11 7/8 x 5 7/8"
32 Units/Bundle
.67 Fc.Ft./Stone

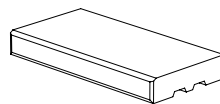

COPING / STEP TREAD
600 x 300 x 75 mm
23 5/8 x 11 7/8 x 3"
16 Units/Bundle
1.94 Fc.Ft./Stone

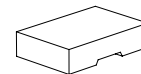

WEDGE CAP UNIT
215 x 323 x 75mm
8 1/2 x 12 3/4 x 3"
96 Units/Bundle
.17 Fc.Ft./Stone

Notes: Maximum height without setback 36" (under optimum conditions). Maximum height with setback is 42" (under optimum conditions). Higher walls can be achieved using geogrid reinforcement. XL units will allow for a minimum 9ft. outside radius. Wedge cap radius = 7", contains 8 Closed-end units per bundle. Closed-end not sold separately. All Concord Wall™ is shipped on refundable skid. Closed-end step tread is available. Unilock, through Risi Stone® Systems International, can provide preliminary site engineering for most commercial projects. Soils information, site drawings, and loading requirements are some of the information details required in order to provide this preliminary site engineering. Contact your local Unilock Representative for details. Retaining wall engineering software is also available free of charge at www.unilock.com.

Dura Hold®



APPLICATIONS

Structural Walls

APPEARANCE

Surface Texture - Smooth

CROSS SECTIONS

Cross Sections are available on Unilock's Contractor website under Products: contractor.unilock.com

TECHNICAL INFORMATION

Conforms to ASTM C1372

Eligible for LEED v4.1 credits

| | STANDARD | STANDARD HALF | CORNER 45° | CORNER 90° |
|----------------|----------|---------------|------------|------------|
| Bundle Type | SINGLE | SINGLE | SINGLE | SINGLE |
| Plant Produced | ONTARIO | ONTARIO | ONTARIO | ONTARIO |
| Thickness (mm) | 300 mm | 300 mm | 300 mm | 300 mm |

| FCFT PER | Stone | 6.02 | 3.00 | 7.04 | 7.04 |
|----------|--------|------|------|------|------|
| | Bundle | 6.02 | 3.00 | 7.04 | 7.04 |

| LNFT PER | Unit | 6.02 | 3.00 | - | - |
|----------|--------|------|------|---|---|
| | Bundle | 6.02 | 3.00 | - | - |

| UNITS PER | SqFt | 0.17 | 0.33 | 0.14 | 0.14 |
|-----------|--------|------|------|------|------|
| | Bundle | 1 | 1 | 1 | 1 |

| LBS PER | Units | 1,680 | 800 | 1,480 | 1,320 |
|---------|--------|-------|-----|-------|-------|
| | Bundle | 1,680 | 800 | 1,480 | 1,320 |

| Colors | Reflectance | Stock | Stock | Stock | Stock |
|---------|----------------|-------|-------|-------|-------|
| Natural | SR n/a SRI n/a | SO | SO | SO | SO |



NATURAL

SINGLE UNITS

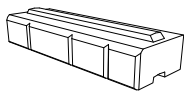

STANDARD

1830 x 600 x 300mm
72 x 23 5/8 x 11 7/8"
1 Unit/Bundle
6.02 Fc.Ft./Stone

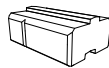

STANDARD HALF

915 x 600 x 300 mm
36 x 23 5/8 x 11 7/8"
1 Unit/Bundle
3.00 Fc.Ft./Stone

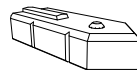

CORNER 45°

1520 x 600 x 300mm
59 7/8 x 23 5/8 x 11 7/8"
1 Unit/Bundle
7.04 Fc.Ft./Stone

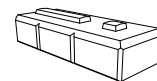

CORNER 90°

1520 x 600 x 300mm
59 7/8 x 23 5/8 x 11 7/8"
1 Unit/Bundle
7.04 Fc.Ft./Stone

Notes: Special Order. Lead time required. SOLD IN FULL BUNDLES ONLY. Closed-end coping units are closed on both ends so that they may be used as left or right units. Tie-back units are reinforced with steel. 1/2 Standard units are slightly tapered and can be used to create a 45 foot radius. Refer to terms and conditions for placement rates. Unilock, through Risi Stone® Systems International, can provide preliminary site engineering for most commercial projects. Soils information, site drawings, and loading requirements are some of the information details required in order to provide this preliminary site engineering. All measurements are nominal. Contact Unilock for more information.

Dura Hold®



APPLICATIONS

Structural Walls

APPEARANCE

Surface Texture - Smooth

CROSS SECTIONS

Cross Sections are available on Unilock's Contractor website under Products: contractor.unilock.com

TECHNICAL INFORMATION

Conforms to ASTM C1372

Eligible for LEED v4.1 credits

| | TIE-BACK | COPING HALF | COPING STANDARD | COPING CLOSED-END |
|----------------|----------|-------------|-----------------|-------------------|
| Bundle Type | SINGLE | SINGLE | SINGLE | SINGLE |
| Plant Produced | ONTARIO | ONTARIO | ONTARIO | ONTARIO |
| Thickness (mm) | 300 mm | 300 mm | 300 mm | 300 mm |

| FCFT PER | Stone | 2.00 | 2.95 | 6.02 | 6.02 |
|----------|--------|------|------|------|------|
| | Layer | 2.00 | 2.95 | 6.02 | 6.02 |
| | Bundle | 2.00 | 2.95 | 6.02 | 6.02 |

| PER BUNDLE | Layers | 1 | 1 | 1 | 1 |
|------------|--------|---|---|---|---|
|------------|--------|---|---|---|---|

| LNFT PER | Unit | - | 3.00 | 6.00 | 6.02 |
|----------|--------|---|------|------|------|
| | Bundle | - | 3.00 | 6.00 | 6.02 |

| UNITS PER | SqFt | 0.50 | 0.34 | 0.17 | 0.17 |
|-----------|--------|------|------|------|------|
| | Layer | 1 | 1 | 1 | 1 |
| | Bundle | 1 | 1 | 1 | 1 |

| LBS PER | Units | 1,660 | 780 | 1,560 | 1,560 |
|---------|--------|-------|-----|-------|-------|
| | Layer | 1,660 | 780 | 1,560 | 1,560 |
| | Bundle | 1,660 | 780 | 1,560 | 1,560 |

| Colors | Reflectance | Stock | Stock | Stock | Stock |
|---------|----------------|-------|-------|-------|-------|
| Natural | SR n/a SRI n/a | SO | SO | SO | SO |



NATURAL

SINGLE UNITS

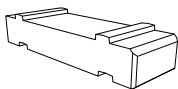

TIE-BACK

1830 x 600 x 300mm
72 x 23 5/8 x 11 7/8"
1 Unit/Bundle
2.00 Fc.Ft./Stone

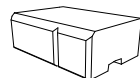

COPING HALF

915 x 600 x 300mm
36 x 23 5/8 x 11 7/8"
1 Unit/Bundle
2.95 Fc.Ft./Stone

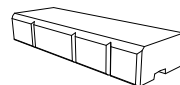

COPING STANDARD

1830 x 600 x 300mm
72 x 23 5/8 x 11 7/8"
1 Unit/Bundle
6.02 Fc.Ft./Stone

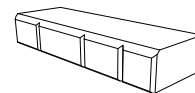

COPING CLOSED-END

1830 x 600 x 300mm
72 x 23 5/8 x 11 7/8"
1 Unit/Bundle
6.02 Fc.Ft./Stone

Notes: Special Order. Lead time required. SOLD IN FULL BUNDLES ONLY. Closed-end coping units are closed on both ends so that they may be used as left or right units. Tie-back units are reinforced with steel. 1/2 Standard units are slightly tapered and can be used to create a 45 foot radius. Unilock, through Risi Stone® Systems International, can provide preliminary site engineering for most commercial projects. Soils information, site drawings, and loading requirements are some of the information details required in order to provide this preliminary site engineering. All measurements are nominal. Contact Unilock for more information.

Dura Hold 2®



| | TIE-BACK | CORNER 90° | STANDARD | COPING | COPING CLOSED-END |
|----------------|----------|------------|----------|---------|-------------------|
| Bundle Type | SINGLE | SINGLE | SINGLE | SINGLE | SINGLE |
| Plant Produced | ONTARIO | ONTARIO | ONTARIO | ONTARIO | ONTARIO |
| Thickness (mm) | 300 mm | 300 mm | 300 mm | 300 mm | 300 mm |

| FCFT PER | Stone | 1.17 | 4.17 | 6.02 | 6.02 | 6.02 |
|----------|--------|------|-------|-------|-------|-------|
| | Layer | 2.34 | 8.34 | 12.05 | 12.05 | 12.05 |
| | Bundle | 4.60 | 16.67 | 24.10 | 24.10 | 24.10 |

| PER BUNDLE | Layers | 2 | 2 | 2 | 2 | 2 |
|------------|--------|---|---|---|---|---|
|------------|--------|---|---|---|---|---|

| LNFT PER | Unit | - | - | 6.00 | 6.00 | 6.00 |
|----------|--------|---|---|-------|-------|-------|
| | Bundle | - | - | 24.00 | 24.00 | 24.00 |

| UNITS PER | SqFt | 0.85 | 0.24 | 0.17 | 0.17 | 0.17 |
|-----------|--------|------|------|------|------|------|
| | Layer | 2 | 2 | 2 | 2 | 2 |
| | Bundle | 4 | 4 | 4 | 4 | 4 |

| LBS PER | Units | 938 | 460 | 938 | 884 | 884 |
|---------|--------|-------|-------|-------|-------|-------|
| | Layer | 1,876 | 920 | 1,876 | 1,768 | 1,768 |
| | Bundle | 3,752 | 1,840 | 3,752 | 3,536 | 3,536 |

| Colors | Reflectance | Stock | Stock | Stock | Stock | Stock |
|---------|----------------|-------|-------|-------|-------|-------|
| Natural | SR n/a SRI n/a | SO | SO | SO | SO | SO |

APPLICATIONS

Structural Walls

APPEARANCE

Surface Texture - Smooth

CROSS SECTIONS

Cross Sections are available on Unilock's Contractor website under Products: contractor.unilock.com

TECHNICAL INFORMATION

Conforms to ASTM C1372

Eligible for LEED v4.1 credits



NATURAL

SINGLE UNITS

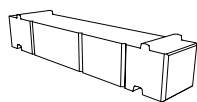

TIE-BACK
1830 x 360 x 300mm
72 x 14 1/4 x 11 7/8"
4 Units/Bundle
1.17 Fc.Ft./Stone

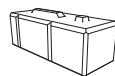

CORNER 90°
900 x 360 x 300mm
35 1/2 x 14 1/4 x 11 7/8"
4 Units/Bundle
4.17 Fc.Ft./Stone

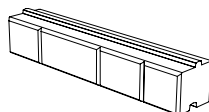

STANDARD
1830 x 360x 300mm
72 x 14 1/4 x 11 7/8"
4 Units/Bundle
6.02 Fc.Ft./Stone

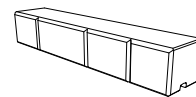

COPING
1830 x 360 x 300mm
72 x 14 1/4 x 11 7/8"
4 Units/Bundle
6.02 Fc.Ft./Stone

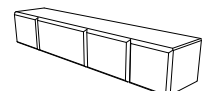

COPING CLOSED-END
1830x 300 x 360mm
72 x 11 7/8 x 14 1/4"
4 Units/Bundle
6.02 Fc.Ft./Stone

Notes: Special Order. Lead time required. SOLD IN FULL BUNDLES ONLY. Closed-end coping units are closed on both ends so that they may be used as left or right units. Tie-back units are reinforced with steel. Unilock, through Risi Stone® Systems International, can provide preliminary site engineering for most commercial projects. Soils information, site drawings, and loading requirements are some of the information details required in order to provide this preliminary site engineering. All measurements are nominal. Contact Unilock for more information.

Estate Wall™



| | 3" RANDOM BUNDLE | 3" PILLAR/CORNER | 6" RANDOM BUNDLE | 6" PILLAR/CORNER | COPING BUNDLE |
|----------------|------------------|------------------|------------------|------------------|---------------|
| Bundle Type | RANDOM | SINGLE | RANDOM | SINGLE | RANDOM |
| Plant Produced | UXBRIDGE | UXBRIDGE | UXBRIDGE | UXBRIDGE | UXBRIDGE |
| Thickness (mm) | 75 mm | 75 mm | 150 mm | 150 mm | 75 mm |

| FCFT PER | Stone | 0.25 | 0.26 | 0.50 | 0.51 | 0.23 |
|----------|--------|-------|-------|-------|-------|-------|
| | Layer | 3.00 | 2.05 | 6.00 | 4.10 | 2.10 |
| | Bundle | 24.00 | 16.38 | 24.00 | 16.38 | 14.70 |

| PER BUNDLE | Layers | 8 | 8 | 4 | 4 | 7 |
|------------|--------|---|---|---|---|---|
|------------|--------|---|---|---|---|---|

| LNFT PER | Unit | - | - | - | - | 0.90 |
|----------|--------|---|---|---|---|-------|
| | Bundle | - | - | - | - | 56.87 |

| UNITS PER | SqFt | 4.00 | 3.91 | 2.00 | 1.95 | 4.29 |
|-----------|--------|------|------|------|------|------|
| | Layer | 12 | 8 | 12 | 8 | 9 |
| | Bundle | 96 | 64 | 48 | 32 | 63 |

| LBS PER | Units | - | 33 | - | 56 | 33 |
|---------|--------|-------|-------|-------|-------|-------|
| | Layer | 271 | 264 | 585 | 444 | 294 |
| | Bundle | 2,164 | 2,110 | 2,340 | 1,776 | 2,060 |

| Colors | Reflectance | Stock | Stock | Stock | Stock | Stock |
|--------------|----------------|-------|-------|-------|-------|-------|
| Almond Grove | SR.n/a SRI n/a | ✓ | ✓ | ✓ | ✓ | ✓ |
| Granite | SR.n/a SRI n/a | ✓ | ✓ | ✓ | ✓ | ✓ |
| Sierra | SR.n/a SRI n/a | ✓ | ✓ | ✓ | ✓ | ✓ |
| Charcoal | SR.n/a SRI n/a | - | - | - | - | ✓ |

APPLICATIONS

Pillar, Steps, Outdoor Kitchen, Fire Feature, Water Feature, Garden Wall, Seat Wall

APPEARANCE

Surface Texture - Split

CROSS SECTIONS

Cross Sections are available on Unilock's Contractor website under Products: contractor.unilock.com

TECHNICAL INFORMATION

Conforms to ASTM C 1372

Eligible for LEED v4.1 credits

// Scan here for Installation PDF



ALMOND GROVE



GRANITE



SIERRA



CHARCOAL
(Coping Only)

3" SINGLE UNIT

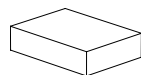

3" PILLAR/CORNER
318 x 229 x 75mm
12 1/2 x 9 x 3"
64 Units/Bundle
.26 Fc.Ft./Stone

6" SINGLE UNIT

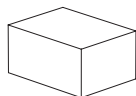

6" PILLAR/CORNER
318 x 229 x 150mm
12 1/2 x 9 x 5 7/8"
32 Units/Bundle
.51 Fc.Ft./Stone

COPING BUNDLE



COPING TAPERED
317.5 x 304.8 x 76.2mm
12 1/2 x 12 x 3"
56 Units/Bundle
.26 Fc.Ft./Stone



CLOSED-END COPING UNIT
317.5 x 304.8 x 76.2mm
12 1/2 x 12 x 3"
7 Units/Bundle
.26 Fc.Ft./Stone

3" RANDOM BUNDLE

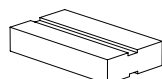

3" LARGE UNIT
406 x 228 x 75mm
16 x 9 x 3"
32 Units/Bundle
.33 Fc.Ft./Stone

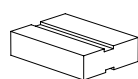

3" MEDIUM UNIT
305 x 228 x 75mm
12 x 9 x 3"
32 Units/Bundle
.24 Fc.Ft./Stone

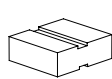

3" SMALL UNIT
203 x 228 x 75mm
8 x 9 x 3"
32 Units/Bundle
.16 Fc.Ft./Stone

6" RANDOM BUNDLE

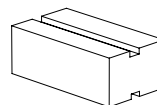

6" LARGE UNIT
406 x 228 x 150mm
16 x 9 x 5 7/8"
16 Units/Bundle
.66 Fc.Ft./Stone

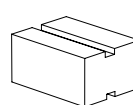

6" MEDIUM UNIT
305 x 228 x 150mm
12 x 9 x 5 7/8"
16 Units/Bundle
.48 Fc.Ft./Stone

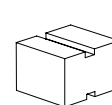

6" SMALL UNIT
203 x 228 x 150mm
8 x 9 x 5 7/8"
16 Units/Bundle
.33 Fc.Ft./Stone

Notes: SOLD IN FULL BUNDLES ONLY and is produced and sold on a required, refundable skid. 3" and 6" random wall bundles have convertible large units that can be used for corners or ending seat walls. End caps not sold separately. All measurements are nominal. Contact Unilock for more information.

Lineo™ Dimensional Stone



APPLICATIONS

Pillar, Outdoor Kitchen, Fire Feature, Water Feature, Seat Wall, Garden Wall

APPEARANCE

Surface Texture - Smooth

CROSS SECTIONS

Cross Sections are available on Unilock's Contractor website under Products: contractor.unilock.com

TECHNICAL INFORMATION

Conforms to ASTM C 1372
Eligible for LEED v4.1 credits

// Scan here for Installation PDF



| | | |
|----------------|----------|-----------------|
| | | PILLAR / CORNER |
| Bundle Type | RANDOM | SINGLE |
| Plant Produced | UXBRIDGE | UXBRIDGE |
| Thickness (mm) | 100 mm | 100 mm |

| | | | |
|----------|--------|-------|-------|
| FCFT PER | Stone | - | 0.33 |
| | Layer | 9.97 | 9.00 |
| | Bundle | 29.92 | 27.00 |

| | | | |
|------------|--------|---|---|
| PER BUNDLE | Layers | 3 | 3 |
|------------|--------|---|---|

| | | | |
|----------|--------|-------|-------|
| LNFT PER | Unit | - | 0.99 |
| | Bundle | 89.06 | 80.36 |

| | | | |
|-----------|--------|------|------|
| UNITS PER | SqFt | 2.01 | 3.00 |
| | Layer | 20 | 27 |
| | Bundle | 60 | 81 |

| | | | |
|---------|--------|-------|-------|
| LBS PER | Units | 44 | 30 |
| | Layer | 881 | 814 |
| | Bundle | 2,643 | 2,441 |

| Colors | Reflectance | Stock | Stock |
|--------------|----------------|-------|-------|
| Almond Grove | SR.n/a SRI n/a | ✓ | ✓ |
| Granite | SR.n/a SRI n/a | ✓ | ✓ |
| Graphite | SR.n/a SRI n/a | ✓ | ✓ |
| Sierra | SR.n/a SRI n/a | ✓ | ✓ |

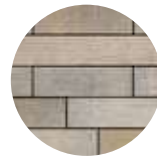

ALMOND GROVE



GRAPHITE

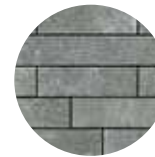

GRANITE



SIERRA

RANDOM BUNDLE

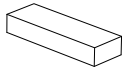

XL RECTANGLE
600 x 200 x 100 mm
23 3/8 x 7 7/8 x 3 7/8"
15 Units/Bundle
.64 Fc.Ft./Stone

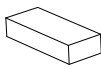

LARGE RECTANGLE
500 x 200 x 100mm
19 3/4 x 7 7/8 x 3 7/8"
15 Units/Bundle
.54 Fc.Ft./Stone



RECTANGLE
400 x 200 x 100mm
15 3/4 x 7 7/8 x 3 7/8"
15 Units/Bundle
.43 Fc.Ft./Stone



SMALL RECTANGLE
300 x 200 x 100mm
11 7/8 x 7 7/8 x 3 7/8"
15 Units/Bundle
.32 Fc.Ft./Stone

SINGLE UNIT



PILLAR/CORNER
300 x 200 x 100mm
11 7/8 x 7 7/8 x 3 7/8"
81 Units/Bundle
.32 Fc.Ft./Stone

NOTES: SOLD IN FULL BUNDLES ONLY and is produced and sold on a required, refundable skid. Spacing strips are shipped with random wall bundles to create even spacing between units. LedgeStone®, Unilock Natural Stone or 6"x12" Fullnose complement as possible coping options. All measurements are nominal. Contact Unilock for more information.

Pisa™ XL Smooth



APPLICATIONS

Garden Wall, Seat Wall, Step, Pillar,
Structural Walls

APPEARANCE

Surface Texture - Smooth

CROSS SECTIONS

Cross Sections are available on Unilock's
Contractor website under Products:
contractor.unilock.com

TECHNICAL INFORMATION

Conforms to ASTM C 1372
Eligible for LEED v4.1 credits

| | CORNER | XL TAPERED | COPING |
|----------------|----------|------------|----------|
| Bundle Type | SINGLE | SINGLE | SINGLE |
| Plant Produced | UXBRIDGE | UXBRIDGE | UXBRIDGE |
| Thickness (mm) | 150 mm | 150 mm | 75 mm |

| FCFT PER | Stone | 0.97 | 0.65 | 0.32 |
|----------|--------|-------|-------|-------|
| | Layer | 11.63 | 5.17 | 1.94 |
| | Bundle | 46.52 | 20.67 | 15.50 |

| PER BUNDLE | Layers | 4 | 4 | 8 |
|------------|--------|---|---|---|
|------------|--------|---|---|---|

| LNFT PER | Unit | - | - | 1.31 |
|----------|--------|---|---|-------|
| | Bundle | - | - | 62.99 |

| UNITS PER | SqFt | 1.03 | 1.55 | 3.10 |
|-----------|--------|------|------|------|
| | Layer | 12 | 8 | 6 |
| | Bundle | 48 | 32 | 48 |

| LBS PER | Units | 58 | 78 | 48 |
|---------|--------|-------|-------|-------|
| | Layer | 696 | 620 | 285 |
| | Bundle | 2,786 | 2,480 | 2,282 |

| Colors | Reflectance | Stock | Stock | Stock |
|--------------|----------------|-------|-------|-------|
| Almond Grove | SR.n/a SRI n/a | ✓ | ✓ | ✓ |
| Granite | SR.n/a SRI n/a | ✓ | ✓ | ✓ |



ALMOND GROVE



GRANITE

SINGLE UNITS

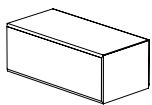

CORNER

400 x 150 x 200mm
15 3/4 x 5 7/8 x 7 7/8"
48 Units/Bundle
.97 Fc.Ft./Stone

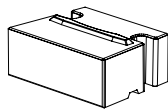

XL TAPERED

400 x 150 x 300mm
15 3/4 x 5 7/8 x 11 7/8"
32 Units/Bundle
.65 Fc.Ft./Stone

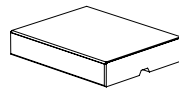

COPING

400 x 75 x 325mm
15 3/4 x 3 x 12 3/4"
48 Units/Bundle
.32 Fc.Ft./Stone

Notes: SOLD IN FULL BUNDLES ONLY and is produced and sold on a required, refundable skid. Maximum height is 42" (under optimum conditions). Higher walls can be achieved using geogrid reinforcement. Unilock, through Risi Stone® Systems International, can provide preliminary site engineering for most commercial projects. Soils information, site drawings, and loading requirements are some of the information details required in order to provide this preliminary site engineering. Contact your local Unilock Representative for details. Retaining wall engineering software is also available free of charge at www.unilock.com.

Pisa™ Edge



APPLICATIONS

Pillar, Steps, Seat Wall, Garden Wall,
Outdoor Kitchen, Structural Walls

APPEARANCE

Surface Texture - Smooth

CROSS SECTIONS

Cross Sections are available on Unilock's
Contractor website under Products:
contractor.unilock.com

TECHNICAL INFORMATION

Conforms to ASTM C 1372
Eligible for LEED v4.1 credits

| | STANDARD/ CORNER | COPING/ CLOSED-END |
|----------------|---------------------|-----------------------|
| Bundle Type | 2 UNIT | 2 UNIT |
| Plant Produced | UXBRIDGE | UXBRIDGE |
| Thickness (mm) | 90 mm | 90 mm |

| FCFT PER | Stone | 0.44 | 0.44 |
|----------|--------|-------|-------|
| | Layer | 3.49 | 3.49 |
| | Bundle | 20.93 | 20.93 |

| PER BUNDLE | Layers | 6 | 6 |
|------------|--------|---|---|
|------------|--------|---|---|

| LNFT PER | Unit | - | - |
|----------|--------|---|---|
| | Bundle | - | - |

| UNITS PER | SqFt | 2.29 | 2.29 |
|-----------|--------|------|------|
| | Layer | 8 | 8 |
| | Bundle | 48 | 48 |

| LBS PER | Units | 52 | 52 |
|---------|--------|-------|-------|
| | Layer | 415 | 415 |
| | Bundle | 2,489 | 2,489 |

| Colors | Reflectance | Stock | Stock |
|-----------|----------------|-------|-------|
| Granite | SR.n/a SRI n/a | ✓ | ✓ |
| Sandstone | SR.n/a SRI n/a | ✓ | ✓ |



GRANITE



SANDSTONE

2 UNIT BUNDLE

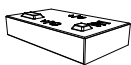

CORNER/CLOSED-END

450 x 260 x 90mm
17 3/4 x 10 1/4 x 3 1/2"
24 Units/Bundle
1.26 Fc.Ft/Stone



STANDARD

450 x 260 x 90mm
17 3/4 x 10 1/4 x 3 1/2"
24 Units/Bundle
1.26 Fc.Ft/Stone

2 UNIT BUNDLE



COPING/CLOSED-END

450 x 260 x 90mm
17 3/4 x 10 1/4 x 3 1/2"
24 Units/Bundle
1.26 Fc.Ft/Stone

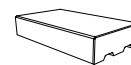

STANDARD

450 x 260 x 90mm
17 3/4 x 10 1/4 x 3 1/2"
24 Units/Bundle
1.26 Fc.Ft/Stone

Notes: SOLD IN FULL BUNDLES ONLY and is produced and sold on a required, refundable skid. Unilock, through Risi Stone® Systems International, can provide preliminary site engineering for most commercial projects. Soils information, site drawings, and loading requirements are some of the information details required in order to provide this preliminary site engineering. Coping units can be used to construct steps. Retaining wall engineering software is also available free of charge at www.unilock.com. All measurements are nominal. Contact Unilock for more information.

Quarry™ Smooth



APPLICATIONS

Pillar, Outdoor Kitchen, Water Feature, Garden Wall, Seat Wall

APPEARANCE

Surface Texture - Standard

CROSS SECTIONS

Cross Sections are available on Unilock's Contractor website under Products: contractor.unilock.com

TECHNICAL INFORMATION

Conforms to ASTM C 1372
Eligible for LEED v4.1 credits

| | WALL | CORNER |
|----------------|----------|----------|
| Bundle Type | RANDOM | SINGLE |
| Plant Produced | UXBRIDGE | UXBRIDGE |
| Thickness (mm) | 114 mm | 114 mm |

| FCFT PER | Stone | 0.38 | 0.38 |
|----------|--------|-------|-------|
| | Layer | 5.63 | 9.05 |
| | Bundle | 28.13 | 18.11 |

| PER BUNDLE | Layers | 5 | 2 |
|------------|--------|---|---|
|------------|--------|---|---|

| LNFT PER | Unit | - | - |
|----------|--------|---|---|
| | Bundle | - | - |

| UNITS PER | SqFt | 2.67 | 2.65 |
|-----------|--------|-------|-------|
| | Layer | 15.00 | 24.00 |
| | Bundle | 75.00 | 48.00 |

| LBS PER | Units | 30 | 40 |
|---------|--------|-------|-------|
| | Layer | 455 | 961 |
| | Bundle | 2,275 | 1,922 |

| Colors | Reflectance | Stock | Stock |
|--------------|----------------|-------|-------|
| Charcoal | SR.n/a SRI n/a | ✓ | ✓ |
| Natural Grey | SR.n/a SRI n/a | ✓ | ✓ |
| Sandstone | SR.n/a SRI n/a | ✓ | ✓ |



CHARCOAL



NATURAL GREY



SANDSTONE

RANDOM BUNDLE

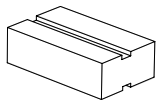

15" LARGE TAPERED
381 x 228.6 x 114.3mm
15 x 9 x 4 1/2"
25 Units/Bundle
.47 Fc.Ft./Stone

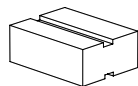

12" MEDIUM TAPERED
304.8 x 228.6 x 114.3mm
12 x 9 x 4 1/2"
25 Units/Bundle
.38 Fc.Ft./Stone

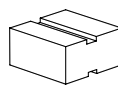

9" SMALL TAPERED
228.6 x 228.6 x 114.3mm
9 x 9 x 4 1/2"
25 Units/Bundle
.28 Fc.Ft./Stone

SINGLE UNITS

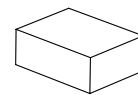

CORNER
306.6 x 114.3 x 228.6mm
12 x 9 x 4 1/2"
48 Units/Bundle
.38Fc.Ft./Stone

Notes: SOLD IN FULL BUNDLES ONLY. And is produced and sold on a required, refundable skid. Maximum height is 36" (under optimum conditions). Pisa XL Smooth coping, LedgeStone™, Brussels Block™ XL, Estate Wall Coping or 6" x 12" Fullnose complement as a possible coping. All measurements are nominal. Contact Unilock for more information.



APPLICATIONS

Pillar, Outdoor Kitchen, Water Feature, Steps, Fire Feature, Seat Wall, Garden Wall

APPEARANCE

Surface Texture - Textured

TECHNICAL INFORMATION

Conforms to ASTM C 1372

LEED Eligible

EPD's & HPD's available

| | WALL | CORNER | JUMPER | CORNER JUMPER |
|----------------|--------|--------|--------|---------------|
| Bundle Type | RANDOM | RANDOM | RANDOM | SINGLE |
| Plant Produced | AYR | AYR | AYR | AYR |
| Thickness (mm) | 57 mm | 57 mm | 114 mm | 114 mm |

| FCFT PER | Stone | 0.19 | 0.41 | 0.34 | 0.55 |
|----------|--------|-------|-------|-------|------|
| | Layer | 3.04 | 4.05 | 3.43 | 4.42 |
| | Bundle | 24.30 | 16.21 | 13.73 | 8.84 |

| PER BUNDLE | Layers | 8 | 4 | 4 | 2 |
|------------|--------|---|---|---|---|
|------------|--------|---|---|---|---|

| LNFT PER | Unit | 1.02 | - | - | 1.48 |
|----------|--------|--------|---|---|-------|
| | Bundle | 130.69 | - | - | 23.62 |

| UNITS PER | SqFt | 5.27 | 2.47 | 2.91 | 1.81 |
|-----------|--------|------|------|------|------|
| | Layer | 16 | 10 | 10 | 8 |
| | Bundle | 128 | 40 | 40 | 16 |

| LBS PER | Units | 16 | 29 | 41 | 61 |
|---------|--------|-------|-------|-------|-----|
| | Layer | 252 | 293 | 408 | 486 |
| | Bundle | 2,015 | 1,173 | 1,631 | 973 |

| Colors | Reflectance | Stock | Stock | Stock | Stock |
|---------------|----------------|-------|-------|-------|-------|
| Buff | SR n/a SRI n/a | ✓ | ✓ | ✓ | ✓ |
| Coastal Slate | SR n/a SRI n/a | ✓ | ✓ | ✓ | ✓ |



BUFF



COASTAL SLATE

CORNER BUNDLE

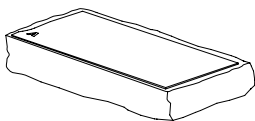

LONG CORNER UNIT

450 x 230-250 x 57mm
17 1/2 x 9-10 x 2 1/4"
20 Units/Bundle



SHORT CORNER UNIT

375 x 230-250 x 57mm
14 1/2 x 9-10 x 2 1/4"
20 Units/Bundle

JUMPER RANDOM BUNDLE



JUMPER UNIT 1

200 x 230-250 x 114mm
8 x 9-10 x 4 1/2"
16 Units/Bundle



JUMPER UNIT 2 & 3

300 x 230-250 x 114mm
12 x 9-10 x 4 1/2"
12 Units/Bundle

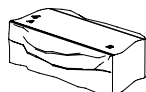

JUMPER UNIT 4

425 x 230-250 x 114mm
17 x 9-10 x 4 1/2"
12 Units/Bundle

JUMPER CORNER UNIT

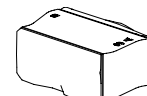

JUMPER CORNER

450 x 230-250 x 114mm
12 x 9-10 x 4 1/2"
16 Units/Bundle

UNITS RANDOM BUNDLE



STANDARD UNIT 1

200 x 230-250 x 57mm
8 x 9-10 x 2 1/4"
32 Units/Bundle

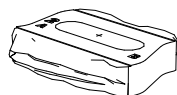

STANDARD UNIT 2

300 x 230-250 x 57mm
12 x 9-10 x 2 1/4"
32 Units/Bundle



STANDARD UNIT 3

300 x 230-250 x 57mm
12 x 9-10 x 2 1/4"
32 Units/Bundle

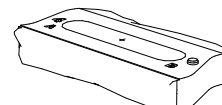

STANDARD UNIT 4

425 x 230-250 x 57mm
17 x 9-10 x 2 1/4"
32 Units/Bundle

Notes: Sold in full bundles only and is produced and sold on a required, refundable skid. All measurements are nominal. Contact Unilock for more information.



APPLICATIONS

Pillar, Outdoor Kitchen, Water Feature, Steps, Fire Feature, Seat Wall, Garden Wall

APPEARANCE

Surface Texture - Textured

TECHNICAL INFORMATION

Conforms to ASTM C 1372
Eligible for LEED v4.1 credits

| | | PILLAR UNIT | FIRE PIT RADIUS WALL |
|----------------|----------------|-------------|----------------------|
| Bundle Type | | SINGLE | SINGLE |
| Plant Produced | | AYR | AYR |
| Thickness (mm) | | 114 mm | 114 mm |
| FCFT PER | Stone | - | - |
| | Layer | - | - |
| | Bundle | - | - |
| PER BUNDLE | Layers | 4 | 4 |
| LNFT PER | Unit | - | - |
| | Bundle | - | - |
| UNITS PER | SqFt | - | - |
| | Layer | 2 | 3 |
| | Bundle | 8 | 12 |
| LBS PER | Units | 220 | 117 |
| | Layer | 441 | 351 |
| | Bundle | 1,764 | 1,402 |
| Colors | Reflectance | Stock | Stock |
| Buff | SR n/a SRI n/a | ✓ | ✓ |
| Coastal Slate | SR n/a SRI n/a | ✓ | ✓ |



BUFF



COASTAL SLATE

PILLAR UNIT

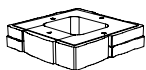

500 x 500 x 114mm
20 x 20 x 4 1/2"
Center opening 9 x 9"

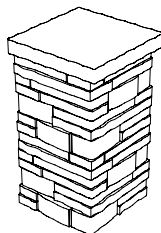

Completed Unit Shown
Pillar cap Sold Separately

FIRE PIT RADIUS WALL UNIT

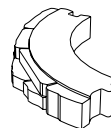

1,060 x 225 x 114mm
41 3/4 x 8 7/8 x 4 1/2"
12 Units/Bundle

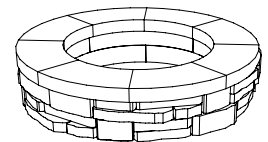

Complete radius wall shown.
Ledgestone Fire Pit coping, insert
and accessories sold separately.

Notes: All measurements are nominal. Contact Unilock for more information.



APPLICATIONS

Seat Wall, Garden Wall, Structural Wall, Steps

APPEARANCE

Surface Texture - Smooth

CROSS SECTIONS

Cross Sections are available on Unilock's Contractor website under Products: contractor.unilock.com

TECHNICAL INFORMATION

Conforms to ASTM C 1372
Eligible for LEED v4.1

| | STANDARD/ CORNER | COPING |
|----------------|---------------------|----------|
| Bundle Type | SINGLE | SINGLE |
| Plant Produced | UXBRIDGE | UXBRIDGE |
| Thickness (mm) | 180 mm | 180 mm |

| FCFT PER | Stone | 1.94 | 1.94 |
|----------|--------|-------|-------|
| | Layer | 7.75 | 7.75 |
| | Bundle | 23.25 | 23.25 |

| PER BUNDLE | Layers | 3 | 3 |
|------------|--------|---|---|
|------------|--------|---|---|

| LNFT PER | Unit | 3.28 | 3.28 |
|----------|--------|-------|-------|
| | Bundle | 39.37 | 39.37 |

| UNITS PER | SqFt | 0.52 | 0.52 |
|-----------|--------|------|------|
| | Layer | 4 | 4 |
| | Bundle | 12 | 12 |

| LBS PER | Units | 257 | 257 |
|---------|--------|-------|-------|
| | Layer | 1,029 | 1,029 |
| | Bundle | 3,086 | 3,086 |

| Colors | Reflectance | Stock | Stock |
|--------------|----------------|-------|-------|
| Almond Grove | SR.n/a SRI n/a | ✓ | ✓ |
| Granite | SR.n/a SRI n/a | ✓ | ✓ |



ALMOND GROVE



GRANITE

SINGLE UNITS

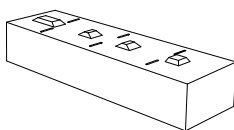

STANDARD/CORNER
1000 x 290 x 180mm
39 3/8 x 11 1/2 x 7"
12 Units/Bundle
1.94 Fc.Ft./Stone

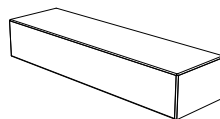

COPING
1000 x 290 x 180mm
39 3/8 x 11 1/2 x 7"
12 Units/Bundle
1.94 Fc.Ft./Stone

Notes: **SOLD IN FULL BUNDLES ONLY** and is produced and sold on a required, refundable skid. Unilock, through Risi Stone® Systems International, can provide preliminary site engineering for most commercial projects. Soils information, site drawings, and loading requirements are some of the information details required in order to provide this preliminary site engineering. Coping units can be used to construct steps. Retaining wall engineering software is also available free of charge at www.unilock.com. All measurements are nominal. Contact Unilock for more information.



| | CORNER SPLIT | 333 SPLIT | 500 SPLIT | 925 SPLIT | COPING SPLIT | CLOSED-END COPING |
|----------------|--------------|-----------|-----------|-----------|--------------|-------------------|
| Bundle Type | SINGLE | SINGLE | SINGLE | SINGLE | SINGLE | SINGLE |
| Plant Produced | UXBRIDGE | UXBRIDGE | UXBRIDGE | UXBRIDGE | UXBRIDGE | GORMLEY |
| Thickness (mm) | 185 mm | 185 mm | 185 mm | 185 mm | 185 mm | 185 mm |

| FCFT PER | Stone | 2.87 | 2.00 | 2.00 | 2.00 | 2.00 | 2.41 |
|----------|--------|-------|-------|-------|------|-------|-------|
| | Layer | 5.73 | 6.00 | 4.00 | 2.00 | 4.00 | 4.81 |
| | Bundle | 17.19 | 18.00 | 12.00 | 6.00 | 12.00 | 14.43 |

| PER BUNDLE | Layers | 3 | 3 | 3 | 3 | 3 | 3 |
|------------|--------|---|---|---|---|---|---|
|------------|--------|---|---|---|---|---|---|

| LNFT PER | Unit | - | 3.25 | 3.25 | 3.25 | - | 3.95 |
|----------|--------|---|-------|-------|------|---|-------|
| | Bundle | - | 29.25 | 19.50 | 9.75 | - | 23.70 |

| UNITS PER | SqFt | 0.35 | 0.50 | 0.50 | 0.50 | 0.50 | 0.42 |
|-----------|--------|------|------|------|------|------|------|
| | Layer | 2 | 3 | 2 | 1 | 2 | 2 |
| | Bundle | 6 | 9 | 6 | 3 | 6 | 6 |

| LBS PER | Units | 477 | 318 | 477 | 954 | 477 | 570 |
|---------|--------|-------|-------|-------|-------|-------|-------|
| | Layer | 954 | 954 | 954 | 954 | 927 | 1,140 |
| | Bundle | 2,862 | 2,862 | 2,862 | 2,862 | 2,780 | 3,420 |

| Colors | Reflectance | SR | n/a | SRI | n/a | Stock | Stock | Stock | Stock | Stock | Stock |
|---------|-------------|---------|-----|-----|-----|-------|-------|-------|-------|-------|-------|
| Granite | SR.n/a | SRI n/a | SO | SO | SO | SO | SO | SO | SO | SO | ✓ |
| Sierra | SR.n/a | SRI n/a | SO | SO | SO | SO | SO | SO | SO | SO | - |

APPLICATIONS

Structural Wall, Garden Wall, Steps

APPEARANCE

Surface Texture - Split

CROSS SECTIONS

Cross Sections are available on Unilock's Contractor website under Products: contractor.unilock.com

TECHNICAL INFORMATION

Conforms to ASTM C 1372

Eligible for LEED v4.1



GRANITE

SIERRA

SINGLE UNITS

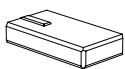

CORNER SPLIT 90°
925 x 500 x 185mm
36 1/2 x 19 3/4 x 7 3/8"
6 Units/Bundle
2.87 Fc.Ft./Stone

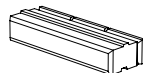

STANDARD 333 SPLIT
1000 x 333 x 185mm
39 3/8 x 13 x 7 3/8"
9 Units/Bundle
2.00 Fc.Ft./Stone

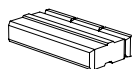

STANDARD 500 SPLIT
1000 x 500 x 185mm
39 3/8 x 19 3/4 x 7 3/8"
6 Units/Bundle
2.00 Fc.Ft./Stone

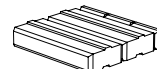

STANDARD 925 SPLIT
1000 x 925 x 185mm
39 3/8 x 36 1/2 x 7 3/8"
3 Units/Bundle
2.00 Fc.Ft./Stone

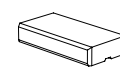

COPING SPLIT
1000 x 500 x 185mm
39 3/8 x 19 3/4 x 7 3/8"
6 Units/Bundle
2.00 Fc.Ft./Stone

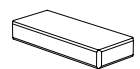

Granite Only
CE COPING
1200 x 500 x 185mm
47 1/4 x 19 3/4 x 7 3/8"
6 Units/Bundle
2.41 Fc.Ft./Stone

Notes: Special Order. Lead time required. Product is sold on a required, refundable skid. Coping units can be used to construct steps. Unilock, through Risi Stone® Systems International, can provide preliminary site engineering for most commercial projects. Soils information, site drawings, and loading requirements are some of the information details required in order to provide this preliminary site engineering. Retaining wall engineering software is also available free of charge at www.unilock.com. All measurements are nominal. Contact Unilock for more information.

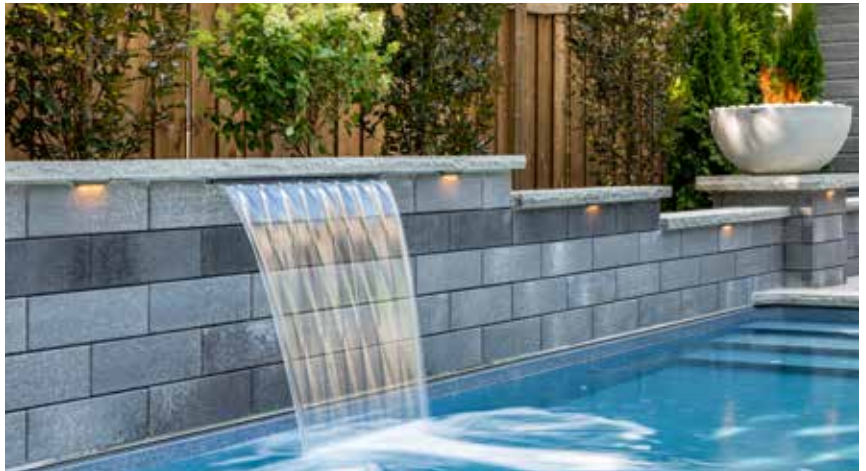

FASCIA PANELS

FINISHES



SMOOTH



PITCHED



UMBRIANO



SUBWAY

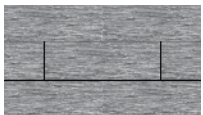

LAVANO

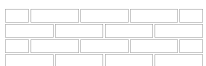

1/2 Running Bond



1/2 Running Bond with Linear Accents



1/2 Running Bond with Random Accents

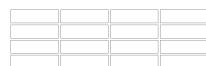

Stacked Bond

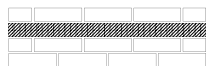

1/2 Running Bond with Paver Accents

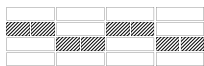

Mixed Bond



1/3 Running Bond



Stacked Bond with Accents



U-CARA RETAINING WALL GEOGRID SECTION

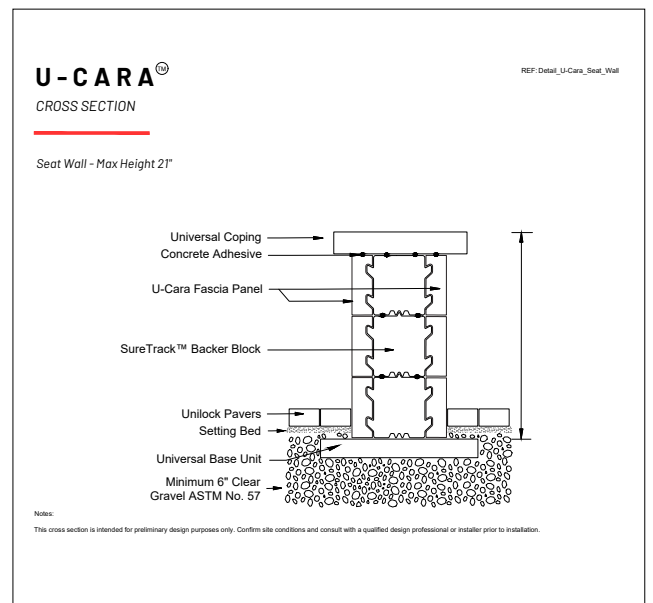
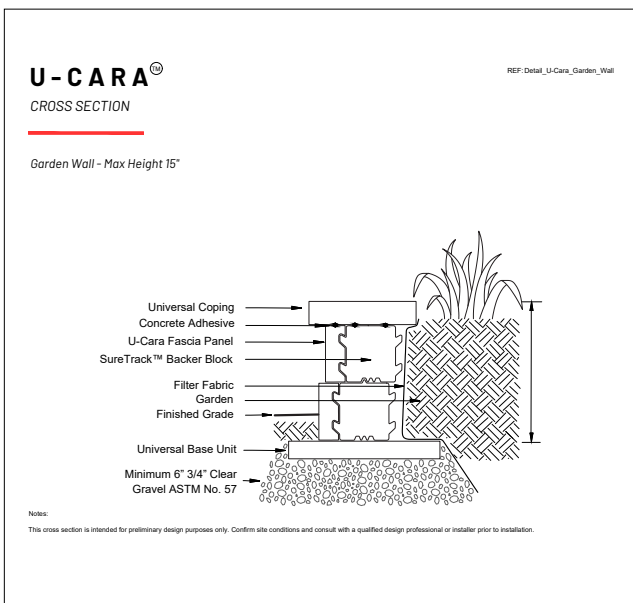
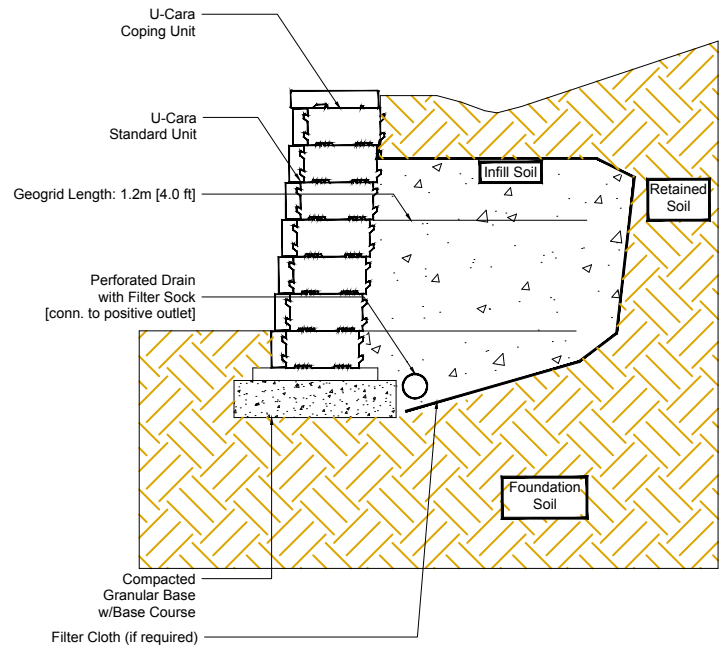

| | 6" STANDARD SMOOTH | 6" CLOSED-END SMOOTH | 6" STANDARD UMBRIANO | 6" CLOSED-END UMBRIANO | 6" STANDARD PITCHED | 6" CLOSED-END PITCHED |
|----------------|--------------------|----------------------|----------------------|------------------------|---------------------|-----------------------|
| Bundle Type | SINGLE | MULTI | SINGLE | MULTI | SINGLE | MULTI |
| Plant Produced | NEW YORK | NEW YORK | ONTARIO | ONTARIO | NEW YORK | NEW YORK |
| Thickness (mm) | 60 mm | 60 mm | 60 mm | 60 mm | 60 mm | 60 mm |

| FCFT PER | Stone | 0.73 | 1.29 | 0.73 | 1.29 | 0.73 | 1.29 |
|----------|--------|-------|-------|-------|-------|-------|-------|
| | Layer | 10.25 | 9.03 | 10.25 | 9.03 | 10.25 | 9.03 |
| | Bundle | 61.52 | 54.18 | 61.52 | 54.18 | 61.52 | 54.18 |

| PER BUNDLE | Layers | 6 | 6 | 6 | 6 | 6 | 6 |
|------------|--------|---|---|---|---|---|---|
|------------|--------|---|---|---|---|---|---|

| LNFT PER | Unit | 1.54 | 2.50 | 1.54 | 2.50 | 1.54 | 2.50 |
|----------|--------|--------|--------|--------|--------|--------|--------|
| | Bundle | 129.50 | 104.86 | 129.50 | 104.86 | 129.50 | 104.86 |

| UNITS PER | SqFt | 1.37 | 0.78 | 1.37 | 0.78 | 1.37 | 0.78 |
|-----------|--------|------|------|------|------|------|------|
| | Layer | 14 | 7 | 14 | 7 | 14 | 7 |
| | Bundle | 84 | 42 | 84 | 42 | 84 | 42 |

| LBS PER | Units | 20 | 30 | 18 | 30 | 21 | 34 |
|---------|--------|-------|-------|-------|-------|-------|-------|
| | Layer | 274 | 207 | 252 | 207 | 291 | 236 |
| | Bundle | 1,647 | 1,240 | 1,513 | 1,240 | 1,745 | 1,415 |

| Colors | Reflectance | Stock | Stock | Stock | Stock | Stock | Stock |
|----------------|----------------|-------|-------|-------|-------|-------|-------|
| Fossil | SR.n/a SRI n/a | ✓ | ✓ | - | - | ✓ | ✓ |
| Granite Fusion | SR.n/a SRI n/a | ✓ | ✓ | - | - | ✓ | ✓ |
| Dark Charcoal | SR.n/a SRI n/a | ✓ | ✓ | - | - | - | - |
| French Grey | SR n/a SRI n/a | - | - | SO | SO | - | - |
| Summer Wheat | SR n/a SRI n/a | - | - | SO | SO | - | - |
| Winter Marvel | SR n/a SRI n/a | - | - | SO | SO | - | - |
| Grenada White | SR n/a SRI n/a | - | - | SO | SO | - | - |
| Midnight Sky | SR n/a SRI n/a | - | - | SO | SO | - | - |

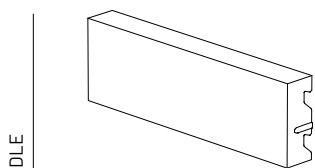

6" STANDARD FASCIA PANEL
 150 x 466 x 60mm
 5 7/8 x 18 3/8 x 2 3/8"
 84 Units/Bundle
 .73 Fc.Ft./Stone

2 UNIT CLOSE-END BUNDLE

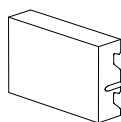

STANDARD FASCIA HALF PANEL
 150 x 233 x 60mm
 5 7/8 x 9 1/4 x 2 3/8"
 42 Units/Bundle
 0.36 Fc.Ft./Stone

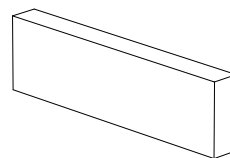

CLOSED-END FASCIA PANEL
 150 x 530 x 60mm
 5 7/8 x 20 7/8 x 2 3/8"
 42 Units/Bundle
 24 rights and 18 lefts 0.93 Fc.Ft./Stone

Notes: Special Order Colors Only. Lead time required. Sold in full bundles. Produced and sold on a required refundable skid. Contact Customer Service for details.



APPLICATIONS

Pillar, Outdoor Kitchen, Water Feature, Fire Feature, Walls up to 3' in Height: Seat Wall, Garden Wall, Retaining Walls, Structural Wall

APPEARANCE

Surface Texture - Smooth, Standard, Umbriano Mottled and Pitched

TECHNICAL INFORMATION

Conforms to ASTM C1372

Eligible for LEED v4.1 credits

| | STANDARD LAVANO | CLOSED-END LAVANO | STANDARD SUBWAY | CLOSED-END SUBWAY |
|----------------|-----------------|-------------------|-----------------|-------------------|
| Bundle Type | SINGLE | MULTI | SINGLE | MULTI |
| Plant Produced | ONTARIO | ONTARIO | ONTARIO | ONTARIO |
| Thickness (mm) | 60 mm | 60 mm | 60 mm | 60 mm |

| FCFT PER | Stone | 0.73 | 1.29 | 0.73 | 1.29 |
|----------|--------|-------|-------|-------|-------|
| | Layer | 10.25 | 9.03 | 10.25 | 9.03 |
| | Bundle | 61.52 | 54.18 | 61.52 | 54.18 |

| PER BUNDLE | Layers | 6 | 6 | 6 | 6 |
|------------|--------|---|---|---|---|
|------------|--------|---|---|---|---|

| LNFT PER | Unit | 1.54 | 2.50 | 1.54 | 2.50 |
|----------|--------|--------|--------|--------|--------|
| | Bundle | 129.50 | 104.86 | 129.50 | 104.86 |

| UNITS PER | SqFt | 1.37 | 0.78 | 1.37 | 0.78 |
|-----------|--------|------|------|------|------|
| | Layer | 14 | 7 | 14 | 7 |
| | Bundle | 84 | 42 | 84 | 42 |

| LBS PER | Units | 18 | 30 | 18 | 30 |
|---------|--------|-------|-------|-------|-------|
| | Layer | 252 | 207 | 252 | 207 |
| | Bundle | 1,513 | 1,240 | 1,513 | 1,240 |

| Colors | Reflectance | Stock | Stock | Stock | Stock |
|----------------|----------------|-------|-------|-------|-------|
| Granite Fusion | SR n/a sRI n/a | S0 | S0 | - | - |
| Fossil | SR n/a sRI n/a | S0 | S0 | - | - |
| Indiana Buff | SR n/a sRI n/a | S0 | S0 | - | - |
| Dark Charcoal | SR n/a sRI n/a | - | - | S0 | S0 |
| Platinum | SR n/a sRI n/a | - | - | S0 | S0 |

SINGLE PANEL BUNDLE

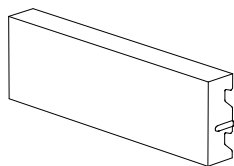

6" STANDARD FASCIA PANEL
 150 x 466 x 60mm
 5 7/8 x 18 3/8 x 2 3/8"
 84 Units/Bundle
 .73 Fc.Ft./Stone

2 UNIT CLOSE-END BUNDLE

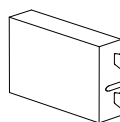

STANDARD FASCIA HALF PANEL
 150 x 233 x 60mm
 5 7/8 x 9 1/4 x 2 3/8"
 42 Units/Bundle
 0.36 Fc.Ft./Stone

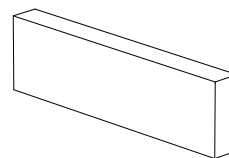

CLOSED-END FASCIA PANEL
 150 x 530 x 60mm
 5 7/8 x 20 7/8 x 2 3/8"
 42 Units/Bundle
 24 rights and 18 lefts 0.93 Fc.Ft./Stone

Notes: Special Order. Lead time required. SOLD IN FULL BUNDLES ONLY. Produced and sold on a required refundable skids. Contact Customer Service for details.

SMOOTH PANELS



FOSSIL



GRANITE FUSION



DARK CHARCOAL

UMBRIANO® PANELS
Lead time required



FRENCH GREY



GRENADA WHITE

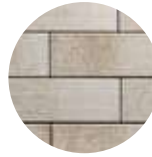

SUMMER WHEAT



WINTER MARVEL



MIDNIGHT SKY

SUBWAY PANELS



DARK CHARCOAL

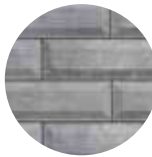

PLATINUM

LAVANO PANELS

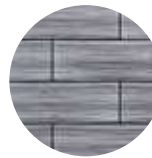

GRANITE FUSION

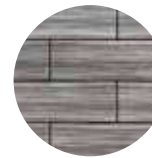

FOSSIL

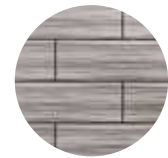

INDIANA BUFF

PITCHED PANELS



FOSSIL



GRANITE FUSION

U-Cara® Backer



| | | CORNER / PILLAR BACKER | LARGE BACKER | STANDARD BACKER |
|------------|----------------|------------------------|--------------|-----------------|
| | Bundle Type | SINGLE | SINGLE | SINGLE |
| | Plant Produced | UXBRIDGE | UXBRIDGE | UXBRIDGE |
| | Thickness (mm) | 150 mm | 150 mm | 150 mm |
| FCFT PER | Stone | 0.28 | 0.32 | 0.31 |
| | Layer | 3.96 | 6.78 | 10.74 |
| | Bundle | 15.82 | 20.35 | 32.21 |
| PER BUNDLE | Layers | 4 | 3 | 3 |
| LNFT PER | Unit | - | 0.66 | 0.62 |
| | Bundle | - | 41.34 | 65.46 |
| UNITS PER | SqFt | 1.32 | 3.10 | 3.26 |
| | Layer | 14 | 21 | 35 |
| | Bundle | 56 | 63 | 105 |
| LBS PER | Units | 36 | 42 | 22 |
| | Layer | 498 | 878 | 772 |
| | Bundle | 1,992 | 2,635 | 2,315 |

EXTRA COMPONENTS



**SURE TRACK
CORNER INSERT**
L = 2"
50mm

SINGLE UNITS

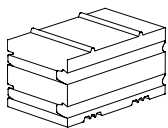

**SURE TRACK
CORNER BACKER**
175 x 150 x 294mm
6 7/8 x 5 7/8 x 11 5/8"
56 Units/Bundle
0.28 Fc.Ft./Stone

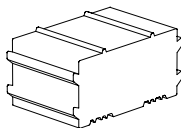

**SURE TRACK
LARGE BACKER**
190 x 150 x 294mm
7 1/2 x 5 7/8 x 11 5/8"
63 Units/Bundle
0.32 Fc.Ft./Stone

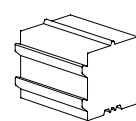

**SURE TRACK
STANDARD BACKER**
190 x 150 x 150mm
7 1/2 x 5 7/8 x 5 7/8"
105 Units/Bundle
0.31 Fc.Ft./Stone

Notes: **SOLD IN FULL BUNDLES ONLY.** Product is shipped on a required, refundable skid. All measurements are nominal. Contact Unilock for more information.

The U-Cara Modular System offers a variety of aluminum frames that can be mixed and matched to construct vertical features like grill islands. Speak to your contractor to select a design and a U-Cara fascia panel finish to suit your project.

With the U-Cara Modular System you can build Grill Islands, Bars, Back splashes, Fire Places and Pillars.



| NO. | MODEL | DESCRIPTION |
|----------------|---------------|---|
| UCARA000001 | URS | UCARA 8' RAIL (10/PACK) |
| UCARA000003 | URS | ALIGNMENT BARS 39" (10/PACK) |
| UCARA000007 | UL-OSK | CABINET DEPTH CHANGE KIT |
| RS-UCARA000009 | UL-FIR | U-CARA FIREPLACE |
| RS-UCARA000010 | UL-FIR-M | U-CARA FIREPLACE MANTLE |
| RS-UCARA000015 | UL-HCK-CC | U-CARA HEIGHT CONVERSION CORNER CAB |
| RS-UCARA000016 | UL-FIR-MW | U-CARA FIREPLACE MANTLE WIDE UNIT |
| RS-UCARA000017 | UL-FIR-CH | U-CARA FIREPLACE CHIMNEY UNIT |
| RS-UCARA000018 | UL-FIR-CH-MW | U-CARA FIREPLACE CHIMNEY WIDE UNIT |
| RS-UCARA000019 | UL-FIR-RTN | U-CARA FIREPLACE RETURN |
| RS-UCARA000020 | UL-FIR-RTN-OS | U-CARA FIREPLACE RETURN OVERSIZED |
| UCARA001000 | UL-GC | UNIVERSAL GRILL CABINET (fits 36-42" grill) |
| UCARA002000 | UL-BC | BASE CABINET (fits fire table or fridge) |
| UCARA003000 | UL-CC | CORNER CABINET 27.5" x 27.5" |
| UCARA003001 | UL-CC-OS | CORNER CABINET 27.5" x 36.5" OS |
| UCARA003002 | UL-CC-BP | CORNER CABINET BACK PANEL |
| UCARA004000 | UL-ECK | END CLAD KIT 27.5" |
| UCARA004001 | UL-ECK-OS | END CLAD KIT 36.5" OS |
| UCARA005000 | UL-BS | BACKSPLASH-GRILL/BASE UNIT 64½" |
| UCARA005001 | UL-BS-CC | BACKSPLASH CORNER CABINET |
| UCARA005002 | UL-BS-CC-OS | BACKSPLASH CORNER CABINET OS |
| UCARA006000 | UL-DD | STAINLESS DOUBLE ACCESS DOORS 27" |
| UCARA007000 | UL-PU | PILLAR UNIT (18⅜" x 18⅜") |

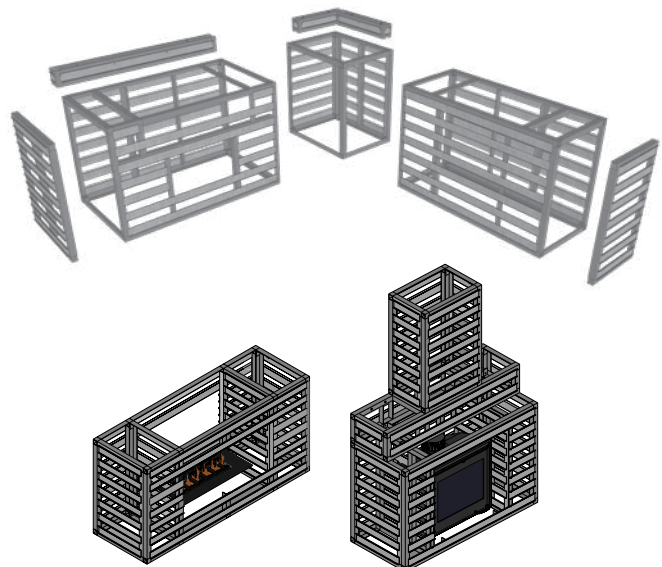



The U-Cara Wall Mount System allows you to put the finishing touches on your project by cladding existing structures like unsightly exposed foundation areas or concrete steps with U-Cara fascia panels.



U-CARA ALIGNMENT BAR:
39" LENGTH - SOLD IN PACKS OF 10 PIECES

U-CARA RAILS:
8' LENGTH - SOLD IN PACKS OF 10 PIECES





APPLICATIONS

Garden Wall, Retaining Wall, Seat Wall,
Fire Feature, Structural Walls

APPEARANCE

Surface Texture - Standard / Smooth

TECHNICAL INFORMATION

Conforms to ASTM C 1372
Eligible for LEED v4.1 credits

| | |
|----------------|----------------|
| | UNIVERSAL BASE |
| Bundle Type | SINGLE |
| Plant Produced | UXBRIDGE |
| Thickness (mm) | 55 mm |

| | | |
|----------|--------|---|
| FCFT PER | Stone | - |
| | Layer | - |
| | Bundle | - |

| | | |
|------------|--------|---|
| PER BUNDLE | Layers | 9 |
|------------|--------|---|

| | | |
|----------|--------|-------|
| LNFT PER | Unit | 1.58 |
| | Bundle | 85.50 |

| | | |
|-----------|--------|----|
| UNITS PER | SqFt | - |
| | Layer | 6 |
| | Bundle | 54 |

| | | |
|---------|--------|-------|
| LBS PER | Units | 46 |
| | Layer | 278 |
| | Bundle | 2,502 |

| Colors | Reflectance | Stock |
|---------|----------------|-------|
| Natural | SR.n/a SRI n/a | ✓ |



NATURAL

SINGLE UNIT

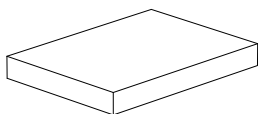

482 x 355 x 55mm
19 x 14 x 2 1/4"
54 Units/Bundle

Notes: **SOLD IN FULL BUNDLES ONLY** and is shipped on a required, refundable skid. Universal base unit is recommended as a base for all walls. All measurements are nominal. Contact Unilock for more information.

Architectural Coping and Pillar Cap



APPLICATIONS

Wall Coping, Pillar

APPEARANCE

Surface Texture - Smooth

TECHNICAL INFORMATION

Conforms to ASTM C 936

Eligible for LEED v4.1 credits

| | | |
|----------------|-----------------------|-------------------|
| | 28 x 28 PILLAR CAP | 12 x 24 COPING |
| Bundle Type | SINGLE | SINGLE |
| Plant Produced | NEW YORK | UXBRIDGE |
| Thickness (mm) | 100 mm | 60 mm |

| | | | |
|----------|--------|------|-------|
| FCFT PER | Stone | 0.77 | 0.40 |
| | Layer | 0.77 | 2.40 |
| | Bundle | 3.06 | 14.42 |

| | | | |
|------------|--------|---|---|
| PER BUNDLE | Layers | 4 | 6 |
|------------|--------|---|---|

| | | | |
|----------|--------|------|------|
| LNFT PER | Unit | 2.34 | 2.03 |
| | Bundle | 9.36 | 73.2 |

| | | | |
|-----------|--------|------|------|
| UNITS PER | SqFt | 1.31 | 0.48 |
| | Layer | 1 | 6 |
| | Bundle | 4 | 36 |

| | | | |
|---------|--------|-----|-------|
| LBS PER | Units | 234 | 57 |
| | Layer | 234 | 341 |
| | Bundle | 935 | 2,044 |

| Colors | Reflectance | Stock | Stock |
|---------------|----------------|-------|-------|
| Light Grey | SR n/a SRI n/a | ✓ | ✓ |
| Dark Charcoal | SR n/a SRI n/a | ✓ | ✓ |

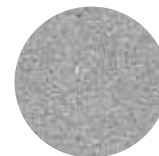

LIGHT GREY



DARK CHARCOAL

SINGLE UNIT

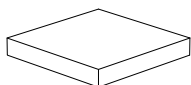

PILLAR CAP

711 x 711 x 100 mm
28 x 28 x 3 7/8"
4 Units/Bundle
.77 Fc.Ft./Stone



COPING

310 x 620 x 60mm
12 x 24 x 2 3/8"
36 Units/Bundle
.40 Fc.Ft./Stone

Notes: SOLD IN FULL BUNDLES ONLY and is produced and sold on a required, refundable skid. Coping units can be adhered to pool edge using concrete adhesive, or with mortar. Always observe proper construction techniques when adhering pavers to a surface. Consult your local pool contractors for installation specifics. All measurements are nominal. Contact Unilock for more information.



APPLICATIONS

Water Feature, Pool Coping, Fire Feature, Wall Coping, Steps

APPEARANCE

Surface Texture - Smooth

TECHNICAL INFORMATION

Conforms to ASTM C 1372

Eligible for LEED v4.1 credits

| | CHAMFERED 36 x 19 | FULLNOSE 36 x 19 | CHAMFERED 24 x 14 | FULLNOSE 24 x 14 |
|----------------|----------------------|---------------------|----------------------|---------------------|
| Bundle Type | SINGLE | SINGLE | SINGLE | SINGLE |
| Plant Produced | ONTARIO | ONTARIO | ONTARIO | ONTARIO |
| Thickness (mm) | 60 mm | 60 mm | 60 mm | 60 mm |

| FCFT PER | Stone | 0.58 | 0.58 | 0.39 | 0.39 |
|----------|--------|------|------|------|------|
| | Layer | 1.16 | 1.16 | 1.55 | 1.55 |
| | Bundle | 6.96 | 6.96 | 9.30 | 9.30 |

| PER BUNDLE | Layers | 6 | 6 | 6 | 6 |
|------------|--------|---|---|---|---|
|------------|--------|---|---|---|---|

| LNFT PER | Unit | 2.96 | 2.96 | 1.97 | 1.97 |
|----------|--------|-------|-------|-------|-------|
| | Bundle | 35.46 | 35.46 | 47.24 | 47.24 |

| UNITS PER | SqFt | 1.72 | 1.72 | - | - |
|-----------|--------|------|------|----|----|
| | Layer | 2 | 2 | 4 | 4 |
| | Bundle | 12 | 12 | 24 | 24 |

| LBS PER | Unit | 129 | 129 | 63 | 63 |
|---------|--------|-------|-------|-------|-------|
| | Layer | 258 | 258 | 252 | 252 |
| | Bundle | 1,547 | 1,547 | 1,510 | 1,510 |

| Colors | Reflectance | Stock | Stock | Stock | Stock |
|----------------|----------------|-------|-------|-------|-------|
| Oat Beige | SR.n/a SRI n/a | - | - | ✓ | ✓ |
| Indiana Buff | SR.n/a SRI n/a | ✓ | ✓ | ✓ | ✓ |
| Sterling | SR.n/a SRI n/a | ✓ | ✓ | ✓ | ✓ |
| Platinum | SR.n/a SRI n/a | - | - | ✓ | ✓ |
| Granite Fusion | SR.n/a SRI n/a | - | - | ✓ | ✓ |
| Dark Charcoal | SR.n/a SRI n/a | ✓ | ✓ | ✓ | ✓ |



DARK CHARCOAL



INDIANA BUFF



STERLING



PLATINUM

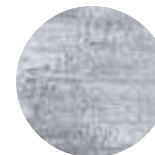

GRANITE FUSION



OAT BEIGE

SINGLE UNITS

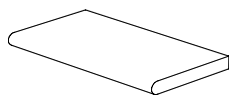

36 x 19 FULLNOSE
900 x 485 x 60 mm
35 1/2 x 19 x 2 3/8
12 Units/Bundle
.58 Fc.Ft/Stone

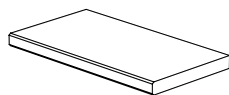

36 x 19 CHAMFERED
900 x 485 x 60 mm
35 1/2 x 19 x 2 3/8
12 Units/Bundle
.58 Fc.Ft/Stone

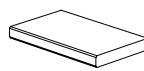

24 x 14 CHAMFERED
600 x 360 x 60 mm
23 5/8 x 14 1/8 x 2 3/8
24 Units/Bundle
.39 Fc.Ft/Stone

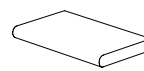

24 x 14 FULLNOSE
600 x 360 x 60 mm
23 5/8 x 14 1/8 x 2 3/8
24 Units/Bundle
.39 Fc.Ft/Stone

Notes: SOLD IN FULL BUNDLES ONLY and is produced and sold on a required, refundable skid. Units can be adhered to pool edge using concrete adhesive, or with mortar. Always observe proper construction techniques when adhering pavers to a surface. Consult your local pool contractors for installation specifics. All measurements are nominal. Contact Unilock for more information.

Fullnose™ 6 x12



APPLICATIONS

Wall Coping, Pillar

APPEARANCE

Surface Texture - Smooth

TECHNICAL INFORMATION

Conforms to ASTM C 936

Eligible for LEED v4.1 credits

| | |
|----------------|----------|
| | STANDARD |
| Bundle Type | SINGLE |
| Plant Produced | UXBRIDGE |
| Thickness (mm) | 60 mm |

| | | |
|----------|--------|---|
| FCFT PER | Stone | - |
| | Layer | - |
| | Bundle | - |

| | | |
|------------|--------|---|
| PER BUNDLE | Layers | 4 |
|------------|--------|---|

| | | |
|----------|--------|--------|
| LNFT PER | Unit | 0.50 |
| | Bundle | 104.00 |

| | | |
|-----------|--------|-----|
| UNITS PER | SqFt | - |
| | Layer | 52 |
| | Bundle | 208 |

| | | |
|---------|--------|-------|
| LBS PER | Unit | 13 |
| | Layer | 698 |
| | Bundle | 2,791 |

| Colors | Reflectance | Stock |
|--------------|-----------------|-------|
| Almond Grove | SR. n/a SRI n/a | ✓ |
| Charcoal | SR. n/a SRI n/a | ✓ |
| Limestone | SR. n/a SRI n/a | ✓ |
| Sierra | SR. n/a SRI n/a | ✓ |

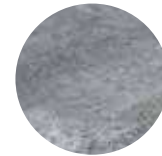

LIMESTONE



SIERRA



ALMOND GROVE



CHARCOAL

SINGLE UNIT

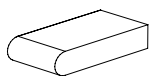

6 x 12
 150 x 300 x 60mm
 5 7/8 x 11 7/8 x 2 3/8"
 208 Units/Bundle

Notes: SOLD IN FULL BUNDLES ONLY and is produced and sold on a required, refundable skid. Units can be adhered to pool edge using Concrete Adhesive, or with mortar. Always observe proper construction techniques when adhering pavers to a surface. Consult your local pool contractors for installation specifics. All measurements are nominal. Contact Unilock for more information.

Ledgestone™ Coping & Closed-End Coping



APPLICATIONS

Pillar, Outdoor Kitchen, Water Feature, Fire Feature, Structural Wall, Steps

APPEARANCE

Surface Texture - Textured

TECHNICAL INFORMATION

Conforms to ASTM C 1776

Eligible for LEED v4.1 credits

| | FULLNOSE COPING | STANDARD COPING | STANDARD CLOSED-END | LARGE COPING | LARGE CLOSED-END |
|----------------|-----------------|-----------------|---------------------|--------------|------------------|
| Bundle Type | SINGLE | SINGLE | SINGLE | SINGLE | SINGLE |
| Plant Produced | CHICAGO | CHICAGO | CHICAGO | CHICAGO | CHICAGO |
| Thickness (mm) | 60 mm | 70 mm | 70 mm | 70 mm | 70 mm |

| FCFT PER | Stone | 0.39 | 0.46 | 0.46 | 0.57 | 0.57 |
|----------|--------|------|------|------|------|------|
| | Layer | 0.39 | 1.38 | 1.38 | 1.72 | 1.72 |
| | Bundle | 5.12 | 5.52 | 5.52 | 6.87 | 6.87 |

| PER BUNDLE | Layers | 13.00 | 4.00 | 4.00 | 4.00 | 4.00 |
|------------|--------|-------|------|------|------|------|
|------------|--------|-------|------|------|------|------|

| LNFT PER | Unit | 2.00 | 2.00 | 2.00 | 2.50 | 2.50 |
|----------|--------|-------|-------|-------|-------|-------|
| | Bundle | 26.00 | 24.00 | 24.00 | 30.00 | 30.00 |

| UNITS PER | SqFt | 2.54 | 2.18 | 2.18 | 1.75 | 1.75 |
|-----------|--------|-------|-------|-------|-------|-------|
| | Layer | 1.00 | 3.00 | 3.00 | 3.00 | 3.00 |
| | Bundle | 13.00 | 12.00 | 12.00 | 12.00 | 12.00 |

| LBS PER | Units | 56 | 64 | 66 | 94 | 93 |
|---------|--------|-----|-----|-----|-------|-------|
| | Layer | 56 | 193 | 199 | 282 | 279 |
| | Bundle | 723 | 772 | 796 | 1,128 | 1,116 |

| Colors | Reflectance | Stock | Stock | Stock | Stock | Stock |
|--------|----------------|-------|-------|-------|-------|-------|
| Buff | SR n/a SRI n/a | ✓ | ✓ | ✓ | ✓ | ✓ |
| Grey | SR n/a SRI n/a | ✓ | ✓ | ✓ | ✓ | ✓ |

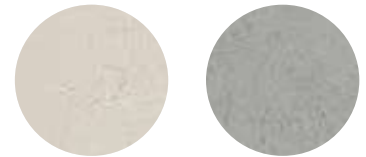

BUFF

GREY

SINGLE UNITS

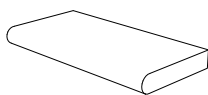

FULLNOSE COPING

610 x 305 x 60mm
24 x 12 x 2 3/8"
13 Units/Bundle
.39 Fc.Ft./Stone

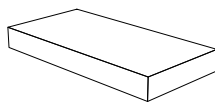

STANDARD COPING

610 x 305 x 70mm
24 x 12 x 2 3/4"
12 Units/Bundle
.46 Fc.Ft./Stone

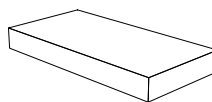

STANDARD CLOSED-END COPING

610 x 305 x 70mm
24 x 12 x 2 3/4"
12 Units/Bundle
.46 Fc.Ft./Stone

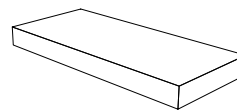

LARGE COPING

762 x 343 x 70mm
30 x 13 1/2 x 2 3/4"
12 Units/Bundle
.57 Fc.Ft./Stone

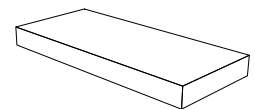

LARGE CLOSED-END COPING

762 x 343 x 70mm
30 x 13 1/2 x 2 3/4"
12 Units/Bundle
.57 Fc.Ft./Stone

Notes: SOLD IN FULL BUNDLES ONLY. This product is produced and sold on a required, refundable skid. Coping is rock faced on the front and the back; Closed-end coping is rock faced on three sides. Units can be adhered to pool edge using concrete adhesive, or with mortar. Always observe proper construction techniques when adhering pavers to a surface. Consult your local pool contractors for installation specifics. All measurements are nominal. Contact Unilock for more information.

Ledgestone™ Pillar Cap & Fire Pit Coping



APPLICATIONS

Pillar, Fire Features

APPEARANCE

Surface Texture - Textured

TECHNICAL INFORMATION

Conforms to ASTM C1776

Eligible for LEED v4.1 credits

| | 24" PILLAR CAP | 21 1/2" FIRE PIT COPING |
|----------------|-------------------|----------------------------|
| Bundle Type | SINGLE | SINGLE |
| Plant Produced | CHICAGO | CHICAGO |
| Thickness (mm) | 100 mm | 65 mm |

| FCFT PER | Stone | 0.66 | - |
|----------|--------|------|---|
| | Layer | 0.66 | - |
| | Bundle | 3.28 | - |

| PER BUNDLE | Layers | 5 | 6 |
|------------|--------|---|---|
|------------|--------|---|---|

| LNFT PER | Unit | 2.01 | - |
|----------|--------|-------|---|
| | Bundle | 10.04 | - |

| UNITS PER | SqFt | - | - |
|-----------|--------|---|----|
| | Layer | 1 | 4 |
| | Bundle | 5 | 24 |

| LBS PER | Unit | 159 | 35 |
|---------|--------|-----|-----|
| | Layer | 159 | 141 |
| | Bundle | 795 | 843 |

| Colors | Reflectance | Stock | Stock |
|--------|----------------|-------|-------|
| Buff | SR n/a SRI n/a | ✓ | ✓ |
| Grey | SR n/a SRI n/a | ✓ | ✓ |



BUFF



GREY

SINGLE UNIT



24 x 24"
610 x 610 x 100mm
24 x 24 x 3 7/8"
5 Units/Bundle
.66 Fc.Ft./Stone



FIRE PIT COPING
254 x 546 x 65mm
10 x 21 1/2 x 2 5/8"
24 Units/Bundle

8 pieces per Fire pit,
Outside Diameter 54"
Inside Diameter 34"

Notes: SOLD IN FULL BUNDLES ONLY. This product is produced and sold on a required, refundable skid. Pillar Cap is rock faced all four sides; All measurements are nominal. Contact Unilock for more information.



APPLICATIONS

Water Feature, Pool Coping, Fire Feature, Wall Coping, Steps

APPEARANCE

Surface Texture - Umbriano Mottled

TECHNICAL INFORMATION

Conforms to ASTM C 1372

Eligible for LEED v4.1 credits

| | CHAMFERED 24 x 14 | FULLNOSE 24 x 14 |
|----------------|----------------------|---------------------|
| Bundle Type | SINGLE | SINGLE |
| Plant Produced | ONTARIO | ONTARIO |
| Thickness (mm) | 60 mm | 60 mm |

| FCFT PER | Stone | 0.39 | 0.39 |
|----------|--------|------|------|
| | Layer | 1.55 | 1.55 |
| | Bundle | 9.30 | 9.30 |

| PER BUNDLE | Layers | 6 | 6 |
|------------|--------|---|---|
|------------|--------|---|---|

| LNFT PER | Unit | 1.97 | 1.97 |
|----------|--------|-------|-------|
| | Bundle | 47.24 | 47.24 |

| UNITS PER | SqFt | - | - |
|-----------|--------|----|----|
| | Layer | 4 | 4 |
| | Bundle | 24 | 24 |

| LBS PER | Unit | 63 | 63 |
|---------|--------|-------|-------|
| | Layer | 252 | 252 |
| | Bundle | 1,510 | 1,510 |

| Colors | Reflectance | Stock | Stock |
|---------------|---------------|-------|-------|
| French Grey | SR .18 SRI 17 | ✓ | ✓ |
| Grenada White | SR .45 SRI 52 | ✓ | ✓ |
| Midnight Sky | SR .17 SRI 15 | ✓ | ✓ |
| Summer Wheat | SR .42 SRI 48 | ✓ | ✓ |
| Winter Marvel | SR .35 SRI 38 | ✓ | ✓ |

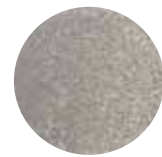

FRENCH GREY



GRENADA WHITE



MIDNIGHT SKY



SUMMER WHEAT



WINTER MARVEL

SINGLE UNITS

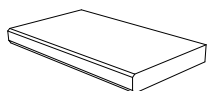

CHAMFERED
600 x 360 x 60 mm
23 5/8 x 14 1/8 x 2 3/8
24 Units/Bundle
.39 Fc.Ft./Stone

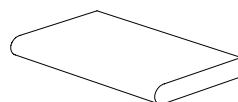

FULLNOSE
600 x 360 x 60 mm
23 5/8 x 14 1/8 x 2 3/8
24 Units/Bundle
.39 Fc.Ft./Stone

Notes: SOLD IN FULL BUNDLES ONLY and is produced and sold on a required, refundable skid. Units can be adhered to pool edge using concrete adhesive, or with mortar. Always observe proper construction techniques when adhering pavers to a surface. Consult your local pool contractors for installation specifics. All measurements are nominal. Contact Unilock for more information.

Lineo™ Dimensional Fire Pit



APPLICATIONS

Fire Feature

APPEARANCE

Surface Texture - Smooth

CROSS SECTIONS

Cross Sections are available on Unilock's

Contractor website under Products:

contractor.unilock.com

TECHNICAL INFORMATION

Conforms to ASTM C 1372

Eligible for LEED v4.1 credits

| | | |
|--|----------------|----------|
| | | SQUARE |
| | Bundle Type | SINGLE |
| | Plant Produced | UXBRIDGE |
| | Thickness (mm) | 100 mm |

| | | |
|-----------------|---------|-----|
| DIAMETER (INCH) | Outside | 43" |
| | Inside | 29" |
| | Insert | 27" |

| | |
|-----------------|----|
| LAYER PER UNIT | 4 |
| UNIT PER LAYER | 12 |
| UNIT PER PALLET | 54 |

| | |
|----------------|-------|
| LBS PER PALLET | 1,628 |
|----------------|-------|

| Colors | Stock |
|--------------|-------|
| Almond Grove | ✓ |
| Granite | ✓ |
| Graphite | ✓ |
| Sierra | ✓ |

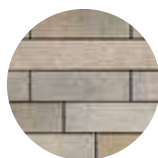

ALMOND GROVE

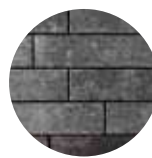

GRAPHITE



GRANITE

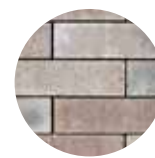

SIERRA

FIRE PIT WARNING

Wood-burning fire pits must be lined with a proper metal insert or refractory (fire-rated) brick to protect the concrete components from extreme exposure to heat. Extreme heat on a concrete surface may affect the structural integrity of the concrete and can be dangerous. The floor of the fire pit should always be constructed using refractory brick or a sand bed. For your safety, always use a spark screen over the fire.

SINGLE UNIT



LINEO FIRE PIT

1100 x 1100 x 400mm
43 3/8 x 43 3/8 x 15 3/4"

ACCESSORIES

The following accessories are available for any fire pit kit. Contact your local Territory Manager for details.



SQUARE FIRE SCREEN
(Special Order only)



24" SWING AWAY GRILL



KETTLE HOOK



ACCESSORY POST WITH COLLAR

NOTES: Firepit uses 48 units total. There will be 6 extra units. Spacing strips are shipped with fire pit bundles to create even spacing between units. LedgeStone™, Unilock Natural Stone or 6"x12" Fullnose complement as possible coping options. All measurements are nominal. Contact Unilock for more information.

RomanStack™ Fire Pit Kit



APPLICATIONS

Fire Feature

APPEARANCE

Surface Texture - Split

TECHNICAL INFORMATION

Conforms to ASTM C 1776

Eligible for LEED v4.1 credits

| | |
|--------------------|----------------------|
| | ROUND |
| Bundle Type | SINGLE |
| Dimension Metric | 1525 x 1525 x 400 mm |
| Dimension Imperial | 60 x 60 x 15 3/4" |

| | | |
|-----------------|---------|----|
| DIAMETER (INCH) | Outside | 60 |
| | Inside | 44 |
| | Insert | 43 |

| | |
|-----------------|----|
| LAYER PER UNIT | 4 |
| UNIT PER LAYER | 24 |
| UNIT PER PALLET | 96 |

| | |
|----------------|-------|
| LBS PER PALLET | 1,725 |
|----------------|-------|

| Colors | Reflectance | Stock |
|--------------|-----------------|-------|
| Almond Grove | SR. n/a SRI n/a | ✓ |
| Granite | SR. n/a SRI n/a | ✓ |
| Sierra | SR. n/a SRI n/a | ✓ |



ALMOND GROVE



GRANITE



SIERRA

SINGLE UNIT



ROMANSTACK ROUND
1525 x 1525 x 400mm
60 x 60 x 15 3/4"

ACCESSORIES

The following accessories are available for any fire pit kit. Contact your local Territory Manager for details.



24" SWING AWAY GRILL



KETTLE HOOK



ACCESSORY POST WITH COLLAR

FIRE PIT WARNING

Wood-burning fire pits must be lined with a proper metal insert or refractory (fire-rated) brick to protect the concrete components from extreme exposure to heat. Extreme heat on a concrete surface may affect the structural integrity of the concrete and can be dangerous. The floor of the fire pit should always be constructed using refractory brick or a sand bed. For your safety, always use a spark screen over the fire.

Notes: All measurements are nominal. Contact Unilock for more information.

Sunset Fire Pit Kit



APPLICATIONS

Fire Feature

APPEARANCE

Surface Texture - Standard

TECHNICAL INFORMATION

Conforms to ASTM C 1372

Eligible for LEED v4.1 credits

| | SQUARE | ROUND |
|--------------------|---------------------------|---------------------------|
| Bundle Type | SINGLE | SINGLE |
| Dimension Metric | 1100 x 1100 x 400 mm | 1300 x 1300 x 400 mm |
| Dimension Imperial | 43 3/8 x 43 3/8 x 15 3/4" | 51 1/4 x 51 1/4 x 15 3/4" |

| DIAMETER (INCH) | Outside | 43 | 52 |
|-----------------|---------|----|----|
| | Inside | 29 | 36 |
| | Insert | 27 | 35 |

| | | |
|-----------------|----|----|
| LAYER PER UNIT | 4 | 4 |
| UNIT PER LAYER | 12 | 18 |
| UNIT PER PALLET | 48 | 72 |

| | | |
|----------------|-------|-------|
| LBS PER PALLET | 1,357 | 1,499 |
|----------------|-------|-------|

| Colors | Reflectance | Stock | Stock |
|-----------|-----------------|-------|-------|
| Sandstone | SR. n/a SRI n/a | ✓ | ✓ |
| Limestone | SR. n/a SRI n/a | ✓ | ✓ |
| Sierra | SR. n/a SRI n/a | ✓ | ✓ |



SANDSTONE



LIMESTONE



SIERRA

SINGLE UNIT



SUNSET SQUARE

1100 x 1100 x 400mm
43 3/8 x 43 3/8 x 15 3/4"



SUNSET ROUND

1300 x 1300 x 400mm
51 1/4 x 51 1/4 x 15 3/4"

FIRE PIT WARNING

Wood-burning fire pits must be lined with a proper metal insert or refractory (fire-rated) brick to protect the concrete components from extreme exposure to heat. Extreme heat on a concrete surface may affect the structural integrity of the concrete and can be dangerous. The floor of the fire pit should always be constructed using refractory brick or a sand bed. For your safety, always use a spark screen over the fire.

UNILOCK REDUCED SMOKE INSERT

SUNSET ROUND FIRE PITS AVAILABLE WITH ZENTRO TECHNOLOGY FIRE PIT INSERT

There's nothing like relaxing around a firepit to bring family and friends closer together. But with ordinary firepits, smoke always blows in someone's face - usually yours. With Unilock Reduced Smoke Inserts, stinging eyes are a thing of the past. Zentro's patent-pending technology reburns smoke before it gets anywhere near your eyes. Say hello to good times and good-bye to smoke.

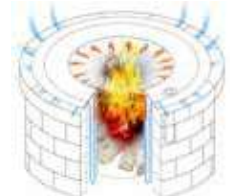

ACCESSORIES

The following accessories are available for any fire pit kit. Contact your local Territory Manager for details.



ROUND FIRE SCREEN
(works with Sunset Round only)



24" SWING AWAY GRILL



KETTLE HOOK



ACCESSORY POST WITH COLLAR

Notes: Ledgestone™ Fire Pit Coping, Unilock Natural Stone or 6"x12" Fullnose complement as possible coping options. All measurements are nominal. Contact Unilock for more information.

NEW from Unilock, the SkyView Roof Deck System is a comprehensive product lineup that includes adjustable pedestals, invisible wind uplift solutions, roof deck slabs, wood tile, and fiberglass grate. Together, these components offer unmatched flexibility, empowering designers to create elevated rooftop spaces that are visually stunning, durable and high-performing. The system's intuitive design also simplifies installation for contractors, ensuring efficiency without compromising quality. With SkyView, reimagine what's possible for roof deck design and construction.

SKYVIEW PEDESTAL SYSTEM

Unilock SkyView Pedestals are patent pending, fully adjustable structural supports for elevating paving materials. Our pedestals ensure unmatched flexibility, ease of installation and durability.



- 1/2" and 1" Waffles available for low profile applications.
- 10" Cores and Collars available for taller applications up to 31".

SKYVIEW GRATE

When this 48 x 48" fiberglass grate is placed on SkyView Pedestals, it creates a stable surface for installing smaller paver units on an elevated roof deck.

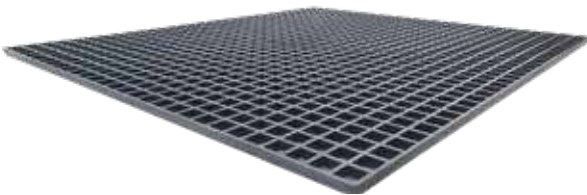

SKYVIEW WIND UPLIFT SYSTEM

When the below components are combined with the SkyView Pedestal System, they create a rafted paving surface with an invisible tie-down mechanism that resists wind uplift pressures without compromising project aesthetics.

1 | Wind Uplift Slabs

24 x 24" slabs featuring a kerfed undercut that spans the length of two opposing sides.

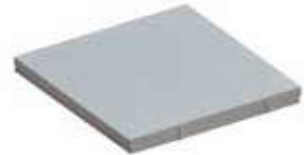

2 | Wind Uplift Kit

This 3-part kit is easily added to SkyView Pedestals to form a tie-down mechanism that works seamlessly with our Wind Uplift Slabs.



SCREW



KEYWAY
LOCKDOWN BAR



PUCK

SKYVIEW IPE WOOD TILE

Sustainably harvested and FSC certified, these 24 x 24" tiles have a dense hardwood composition that makes them perfect for use on SkyView Pedestals.



Ask your Unilock Representative about the made to order roof deck slab options available for your projects.

Cleaners



GATOR CLEAN XP OIL AND GREASE REMOVER

RS-CLN009 - 1 quart; 6/box
24 boxes/pallet (144 units)

Use it on concrete, paver or stone. Do not use on asphalt (blacktop). Not recommended for synthetic oil stains.

- Biodegradable and phosphate-free
- Easily lifts & absorbs embedded oil stains
- No scrubbing, no rinsing, no mess
- Not recommended for synthetic oil stains



GATOR EFFLORESCENCE CLEANER

RS-CLN075 - 1 gallon; 4/box
24 boxes/pallet (96 units)
RS-CLN076 - 5 gallons; 48 pails/pallet

Remove any efflorescence stains trapped in the concrete pavers & natural stone pores. It will make the pavers look more clean and vibrant. This efflorescence cleaning is a necessary step before a sealer is applied. The sealer will be able to get a deeper penetration into the now clean pores.

Sealers



GATOR SEAL SIGNATURE SERIES NATURAL LOOK

RS-SEAL200 - 1 gallon; 4/box;
24 boxes/pallet (96 units)

This sealer penetrates deep into the concrete pavers, walls, masonry and natural stones, therefore helps prevent the oil and dirt penetration, corrosion from de-icing salt, the effects from the UV rays and stains up to 10 years.



GATOR SATIN LOOK SEALER

RS-SEAL207 - 1 gallon; 4/box
24 boxes/pallet (96 units)
RS-SEAL208 - 5 gallons; 48 pails/pallet

Made from acrylic-based polymers GATOR SATIN LOOK SEALER penetrates deep into the concrete pavers, therefore helps prevent the oil and dirt penetration, corrosion from de-icing salt and the effects from the UV rays. Specifically formulated to be used on unsealed surfaces only.



GATOR WET LOOK SEALER

RS-SEAL205 - 1 gallon; 4/box
24 boxes/pallet (96 units)
RS-SEAL206 - 5 gallons; 48 pails/pallet

Made from acrylic-based polymers GATOR WET LOOK SEALER penetrates deep into the concrete pavers, therefore helps prevent the oil and dirt penetration, corrosion from de-icing salt and the effects from the UV rays. Specifically formulated to be used on unsealed surfaces only.



BACK TO BLACK SEALER

RS-SEAL238 - 1 liter; 3 liter/case

- Quickly revives and enhances faded, dark limestone.
- Provides stain & water-resistant surface
- 1 Liter covers up to 400 sqft with one coat depending on surface porosity.

Paver Edging



PERMAPAK

RS-EDGE087 - 30 Packets per box; 1 lb per packet

YIELDS/MIXING/INSTALLATION

- Open graded base: 1 Perma Pak/50-60# bag of concrete will produce a 12'-16' open graded/clear base (chip bedding)
- Dense Base: 1 Perma Pak/50-60# bag of concrete will produce 17'-21' dense/crushed base (sand bedding)
- NOTE: yields may vary depending on the thickness of the bedding layer used. A thicker bedding layer will take more product, yielding fewer linear edging feet.
- One Perma Pak per 50-60 lb. bag of concrete
- Three Perma Paks per two 80 lb. bags of concrete



ALLIANCE GATOR XTREME EDGE

RS-EDGE076 - 50 lb bag; 56 bags per skid.

- The ultimate fiber-reinforced structural edging solution for any hardscape project.
- Can be used for any traditional, open-graded, permeable, Gator Base or overlay application using concrete pavers or slabs, natural and wet cast stones.
- Offers permanent continuous lateral support.
- Approximate Coverage: 20-25 sqft. per bag.

Adhesive



ALLIANCE XP GATOR BLOCK ADHESIVE

RS-ADH035 - 10 oz; 12/case;
90 cases/skid; 1,080 units/skid
RS-ADH038 - 28 oz; 12/case;
60 cases/skid; 720 units/skid

- Bonds permanently in 24 hours
- Material may be repositioned for up to 30 minutes
- Works in temperatures above 32°F
- 850 psi in 24 hrs (-1,000 psi in 7 days)

Permeable Chip Products



ALLIANCE GATOR AQUA ROCK

RS-AGG042 - 50lb./bag, 56 bags/skid
RS-AGG033 - 2200 lb./Super Sack

- Meets ASTM No. 9 requirement for permeable joint units.
- High-strength granite ideal for bedding course & jointing material.
- Coverage: 20-25 Sq.Ft./bag | 880-1100 Sq.Ft./ Super Sack.

Note: Carefully read all instructions and safety information on product label prior to application. For additional safety information, see MSDS.

Sands

SABLE MARCO EV EVOLUTION PRO+SAND



RS-SAND104 - Beige
RS-SAND105 - Grey
RS-SAND106 - Black
50 lb/bag; 63 bags/skid (3,150 lbs/skid)

- A specially formulated high performance mix of graded sand and binding agent to fill pavers joints
- Ideal for the installation of pavers or slabs as well as replacing existing joints on sidewalks, patios, sloped driveways or walkways
- Will remain stable and flexible and maintain its flexibility and durability in the most extreme weather conditions.
- Contains no pigment or dyes
- Coverage: Approx. 100 sq.ft./ bag for narrow joints, larger joints will require more sand.

Note: Extra care must be taken when using on Courtstone, Copthorne, Richcliff and Town Hall. Not recommended for Il Campo, Series or Umbriano.

POLYBIND G2 COMPLETE SAND



RS-SAND152 - Nevada Tan
RS-SAND153 - Oxford Grey
RS-SAND154 - Jet Black
RS-SAND155 - Ivory White
50 lb/bag; 56 bags/skid (2,850 lbs/skid)

NO DUST- HAZE FREE- NO BLOWER- ONE WATERING

Designed for paver joints up to 2".

- RAIN SAFE IN 16 MINUTES
- Made with calibrated sand mixed with sophisticated intelligent polymers, which neutralizes haze and dust
- Recommended for a variety of uses including pool decks, patios, footpaths, driveways, parking spaces, pavements, etc
- Coverage: 65-85 sq.ft./bag for narrow joints, larger joints will require more sand

POLYBIND G2 SAND



RS-SAND150 - Nevada Tan
RS-SAND151 - Oxford Grey
50 lb/bag; 56 bags/skid (2,850 lbs/skid)

NO DUST- HAZE FREE- NO BLOWER- ONE WATERING

- RAIN SAFE IN 16 MINUTES
- Designed for paver joints up to 2".
- A unique mix of polymer binders and calibrated sand.
- Installation almost identical to regular paver joint sand, except for the application of water. Becomes very firm when set & locks between the paver joints.
- Coverage: 65-85 sq.ft./ bag for narrow joints, larger joints will require more sand.



TECHNISEAL PROSERIES SMARTSAND

RS-SAND173 - Tan
RS-SAND174 - Urban Grey
RS-SAND181 - Granite Grey
50 lb/Bag; 56 bags/skid (2,860 lbs/skid)

Designed for paver joints up to a maximum of 1 inch.

- Benefits from the Nextgel technology for cleaner application and faster wetting.
- A smart choice for residential driveways, patios, etc.
- Offers great resistance to weed growth, insect invasion and erosion; fast-setting within minutes of water activation.
- Coverage: 65-85 sq.ft. coverage per bag for narrow joints, larger joints will require more sand installation.

Recommended with extra care for use with Copthorne®, Courtstone®, Richcliff®, Town Hall® & Umbriano® products. It is not suitable for use with Il Campo®, Series™ and Unigranite®. Umbriano's surface must be cleaned with a foam squeegee post installation.

POLYBIND HP SAND



RS-SAND078 - Nevada Tan
RS-SAND080 - Oxford Grey
50 lb/bag • 56 bags/skid (2,850 lbs/skid)

- Unique mixture of polymer binders and calibrated sand
- The installation of POLYBIND SAND is almost identical to using regular paver joint sand except for the application of water. Once POLYBIND SAND sets, it becomes very firm and locks between the paver joints while still retaining flexibility and providing a long lasting, durable jointing material
- Recommended for a variety of uses including pool decks, patios, footpaths, driveways, parking spaces, pavements, etc
- Coverage: 65-85 sq.ft./ bag for narrow joints, larger joints will require more sand.



TECHNISEAL® HP NEXTGEL SAND

RS-SAND131 - Tan
RS-SAND133 - Urban Grey
RS-SAND130 - Granite Grey
RS-SAND203 - Black
50 lb/Bag; 56 bags/skid (2,860 lbs/skid)

NO DUST • NO HAZE • NO WASTE

Designed for paver joints up to a maximum of 1 inch.

- Ideal in high-humidity environments, heavy-vehicular traffic areas & steeper terrain.
- Fast, clean, durable and profitable installation thanks to Nextgel technology.
- Offers great resistance to weed growth, insect invasion and erosion; fast-setting within minutes of water activation.
- Coverage: 65-85 sq.ft. coverage per bag for narrow joints, larger joints will require more sand.

Note: Carefully read all instructions and safety information on product label prior to application. For additional safety information, see MSDS.

Sands (continued)



ALLIANCE GATOR NITRO SAND

- RS-SAND196 - Beige
- RS-SAND197 - Grey
- RS-SAND198 - Black
- RS-SAND236 - Silver

40 lb/Pail; 48 pails/pallet (1,970 lbs/pallet)

- Ready to use permeable jointing material.
- Can be installed in wet or dry weather.
- Formulated for joints from 1/2" to 2".
- Ideal for concrete & wetcast pavers, Natural Stone & Porcelain Tile.
- Coverage: 10-84 Sq.Ft./bucket depending on joint width.



RAPID FLOW TECHNOLOGY

GATOR NITRO-X FINE JOINT

Black | Grey | Gunmetal | Taupe | Platinum | Vanilla
27.5 lbs Pail; 48 Pails/Pallet

- Rapid Flow Technology
- Fast and simple installation
- Xtra Fine gradation jointing sand
- Xtra Low permeability
- Xtra Strength from top to bottom ***
- Apply rain or shine
- Joint width from 1/8" to 2" (3 mm to 50 mm)****
- 5-year limited warrantywidth.

*** Gator Nitro-X Fine Joint Sand will harden from top to bottom up to 2 3/8" (60 mm).

**** Ensure there is ABSOLUTELY NO paver, porcelain tile or stone movement prior to installation to prevent joint cracking.



Reduce excavation time, materials and labor with UCore, exclusively from Unilock.

UCore is a patented, lightweight geofoam block designed to replace traditional gravel backfill in applications such as steps, raised patios, walkways and more.



GREATLY REDUCES or eliminates settlement



SOLUTION FOR TIGHT ACCESS areas where transporting equipment and tools may be challenging



INSTALL IN MINUTES with the use of UCore Connectors, locking units together to create a solid raft



LESS EQUIPMENT ONSITE = less wear and tear on machinery typical for transporting, spreading and compacting gravel backfills



LESS GRAVEL DUST, mess, and clean up after projects



REDUCE YOUR COMPANY'S CARBON FOOTPRINT; estimated five to seven times the number of gravel trucks to deliver same volume of UCore

| GEOFOAM | ITEM # | HEIGHT (mm/in) | WIDTH (mm/in) | DEPTH (mm/in) | WALL SYSTEM |
|------------|--------------|----------------|---------------|---------------|---|
| U-Core 150 | RS-UCORE0150 | 150 (5.9") | 1200 (47.25") | 600 (23.5") | U-Cara®, Pisa™, Brussels Dimensional®, Lineo™ |
| U-Core 180 | RS-UCORE0180 | 180 (7.0") | 1200 (47.25") | 600 (23.5") | SienaEdge™ |

Sealer Best Practices

- The paver surface should be **clean** and free from oil, dirt, dust and any loose material. This ensures a uniform result and allows the sealer to better penetrate the surface.
- The pavers should be **free of any visible efflorescence**.
- If pavers have been sealed before, make sure to resealed with compatible product.
- **Surface must be dry** (48 hours without precipitation) and warm to the touch (morning).
- Joint sand must also be dry.
- Make sure lawn sprinklers are shut off.
- Best air temperature is between **50 degrees to 80 degrees** with no rain forecasted for the next 24 hours.
- It is best to apply product under constant weather conditions and use the **same application method from start to finish**.
- The paver joints should be completely filled with dry correctly-graded joint sand. The top level should not exceed the bottom of the chamfer or **1/8" below** the surface on the non-beveled or tumbled paver surface.
- **Always test the product** on a small hidden area to ensure the results will meet your expectations.
- Always show homeowners samples to ensure expectations.

At this point read all sealer instructions and determine the best sealer for your desired goal. Do you want to retain the original look, enhance the color, or stabilize the sand joint?

- **Read application information as each sealer can be applied differently.**
- **Make sure you have the correct equipment based on type of sealer. Solvent based sealers need solvent resistant sprayers, watering cans or paint trays.** Water base sealers can be generally applied using plastic equipment. Example: solvent based sealers come in metal containers and water based sealers come in plastic containers.
- Care should be taken that no excess sealer material is pooled on the surface during application always back roll. When using solvent based sealers make sure roller is solvent resistant or for all paints. Foam rollers work best and are less likely to pull sand from the joints.
- Stabilizing sealers are generally sprayed or flood coated with a watering can, then back rolled.
- Acrylic non-stabilizing sealers can be sprayed, then back rolled or rolled on using a metal paint tray.
- **Send your most experienced worker to do sealing projects.**

Polysand Best Practices

- Ensure that paver surface has **proper drainage runoff** (Min 1" over 8'). Finished paver height should always be higher than grade to allow proper surface drainage.
- **Do not set pavers in limestone screenings.** This product holds moisture and does not meet the gradation, drainage qualities or strength of coarse concrete sand.
- Make sure pavers are **clean of all construction dust**. Residual construction dust will haze pavers!
- **Compact pavers** into setting bed to create proper interlock.
- Read and review all polysand manufacturers methods of application. **(Read Directions)**
- **Don't rush polysand installation.**
- Paver area must be completely dry.
- Lay bags of polysand over paver area. **Stage bags** in areas of coverage. Example: one bag for 60 square feet.
- **Do not over sweep sand.** Sweep sand back and forth within coverage area to fill paver joints.
- Compact sand into joints. This is a must in achieving proper density of the sand joint (repeat 3 times). Compaction is critical to assuring sand strength.
- Do not fill sand above the chamfer of paver. Sand should sit 1/8" below bottom of chamfer.
- Use a fine-bristle broom to **remove any excess sand from the paver surface**.
- Use a **leaf blower** remove any sand or binder residue.
- **Review all watering directions (each manufacturer has different watering instructions.) This is VERY IMPORTANT!**
- Always start watering at the **bottom of the slope**.
- Always start watering in **controlled areas** per manufacturers recommendations. Example: complete watering in 200 sq. ft. area then move on to the next 200 sq. ft. and repeat.
- During final watering of poly sand, **clean surface by removing excess water** with leaf blower or squeegee depending on paver surface texture. This will remove any leftover binder residue or sand.
- Final thoughts – Always be aware of the weather when installing poly sand. **(Temperature and setting time ratings differ between products.)**
- Refer to all manufacturers websites for installation videos.

Edge Restraints



- 1 piece = 8 linear feet
- 1 bundle = 24 pieces
- 1 bundle = 24 pieces = 192 linear feet
- 1 pallet = 16 bundles = 3,072 linear feet

ALLIANCE GATOR EDGE X4 NEW

RS-EDGE055 8' piece; 24 pcs/bundle
28 bundles/pallet (672 pcs/pallet)

- Gator Edge Products are easy to use and quick to install. Offers great lateral support and makes definition easier for alleys, driveways or sidewalks.
- They are made with 100% polypropylene or polyethylene for strength and flexibility.
- Rigid Edging can be transformed to Flex with a simple cut.



LANDSCAPE SPIKES
50lb case

Unilock Drivegrid System™



UNILOCK DRIVEGRID™ SYSTEM

120x12.5' Roll, 1,500 SqFt/Roll

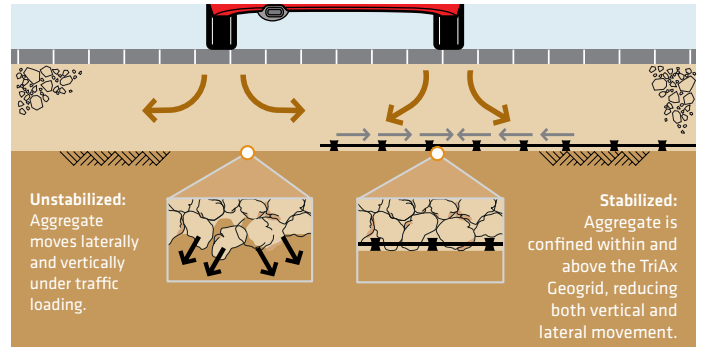

WHY DRIVEGRID SYSTEM™?

- ✓ Easy to install
- ✓ Reduces overall project cost
- ✓ Inexpensive
- ✓ Proven Tensar® TriAx® Technology

Paver Spacers

X & T SLAB SPACERS

RS-ACC237 - X spacers 2" x 2"

RS-ACC236 - T spacers 2" x 1"

- Unilock recommends using slab spacers when installing Arcana and Soreno.
- "T" spacers are needed for running bond patterns; "X" spacers are needed for stack bond patterns.
- Packaging: 250 per bag; X & T bagged separately

Please contact your Territory Manager for more information

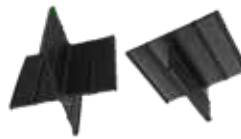

UNILOCK PERMEABLE SPACER NEW

RS-TOOL165-1

Designed for paver joints up to 3/4"

- Create a permeable installation using non-permeable pavers
- Hollow, weather-proof polypropylene (PP) plastic cylindrical elements allow rainwater to flow through into the sub-base
- Rigid and durable, ideal for both vehicular and pedestrian loads

Specifications / Packaging:

- Color: Black
- Dimension: 37mm (h) x 29mm (w)
- Post diameter: 10mm w/6mm drain hole diameter
- Weight: 6g
- Packaging: Bulk



Geotextile & Fabric Products

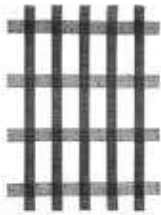

STRATAGRID GEOGRIDS

RS-FAB101 - SGU060

6.25' x 288' (200 Sq Yd) • 85 lbs/roll

RS-FAB010 - SGB030

4' x 50' (22.22 Sq Yd)

- Geogrid reinforcement for soil and aggregates
- Engineered to be mechanically & chemically durable in harsh construction and aggressive soil environments

GATOR GRID 30-30

Packaging & Unilock SKU (Minimum Case Purchase = MCP):

RS-FAB070 - 4' x 50'/12 rolls/case, 60 rolls/skid * MCP *

RS-FAB071 SPECIAL ORDER - 6' x 50' - 40 rolls/skid

RS-FAB072 - 6' x 150'/25 rolls/skid

- A biaxial geogrid, provides strength, longevity, excellent stress transfer and prevents failure to the internal structure of landing areas, retaining walls and steep slopes
- Has a high molecular weight as well as high-tenacity polyester yards which are woven in tension and finished with a PVC coating

GATOR FABRIC NON-WOVEN 4.4

Packaging & Unilock SKU (Minimum Case Purchase = MCP):

RS-FAB043 - 3' x 100' - 6 rolls/case, 24 rolls/skid SPECIAL ORDER * MCP *

RS-FAB044 - 4' x 100' - 6 rolls/case, 36 rolls/skid * MCP *

RS-FAB046 - 6' x 100' - 30 rolls/skid * MCP *

RS-FAB047 - 6' x 300' - 16 rolls/skid * MCP *

- A needle punched non-woven geotextile made of polypropylene fiber, ideal for drainage, filtration and will allow water flow of 135 gallons per minutes per square foot (613 L/min/sq. m.) in paver or retaining wall applications
- Its filament fibers are used for soil separation and drainage and combine high durability along with excellent physical and hydraulic properties
- Non-biodegradable and resistant to most soil chemicals

Stainless Steel Fireplace Insert

STAINLESS STEEL FIREPLACE INSERT

RS-FIR033 - 36" Unit; Order with RS-FIR041 (18" Flue Pipe), RS-FIR042 (36" Flue Pipe) & RS-FIR036-1 (Termination Cap)

RS-FIR034 - 42" Unit; (special order); Order with RS-FIR042 (36" Flue Pipe) & RS-FIR036-1 (Termination Cap)

- Outdoor, Wood-burning Fireplace.
- Insert comes with refractory panels, mesh spark screen and solid steel log grate.
- 254 lbs./Full Kit

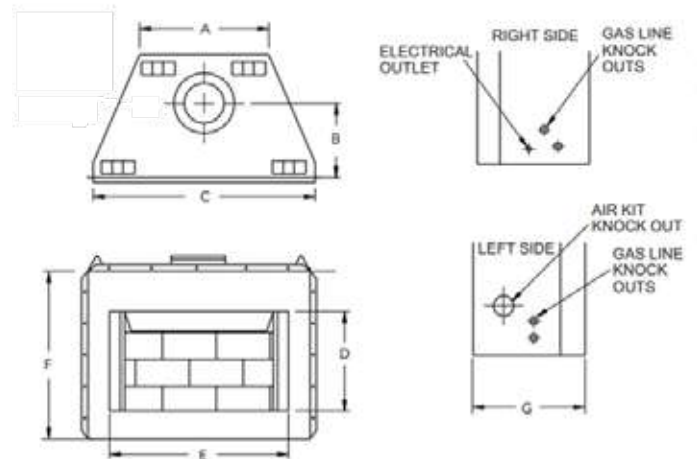

| | 36" | 42" |
|---|---------|---------|
| A | 29" | 36" |
| B | 11-3/4" | 11-3/4" |
| C | 41" | 48" |
| D | 21" | 24" |
| E | 35" | 42" |
| F | 37" | 41" |
| G | 21" | 22-1/2" |

PaverSaver Uni Mat



PAVERSAVER UNI MAT

RS-TOOL121

Universal Design - for use on most compactors

The PaverSaver Uni Mat is made out of a specially formulated urethane rubber. Material soft enough to protect the paver surface yet hard enough to minimally affect travel speed. The universal sizing fits most compactor plates and easily attaches and detaches from the compactor.

Tools & Accessories



INSTALL UP TO 700 SQ. FT. PER HOUR!

- Access tight or narrow areas
- Eliminate the need for a forklift on site
- Reduce labor costs
- Reduce shoulder, hand & knee pain and injury
- Improve your bottom line
- Contact your Territory Manager for details



**RS-TOOL394
MODEL L**



**RS-TOOL395
MODEL PM**



**RS-TOOL511
MODEL MINI**



**RS-TOOL575
ALL TERRAIN
PALLET MOVER**



**STANDARD AND CUSTOM HEADS AVAILABLE
FOR LIFTING ALMOST ANYTHING!**

- Small or Large
- Smooth or Rough
- Textured Designs
- Exposed Aggregate
- Patterned
- Natural Stone
- Retaining Walls



Important notes

UNILOCK PAVER PATTERNS

This Product Data Guide contains an extensive reference to patterns and designs. The purpose of these pattern swatches is to help the designer plan unique and exceptional designs. The percentages of products shown are based on the pattern and not on bundle configurations. In fact, there may be situations in which a pattern has been created with one particular size of stone, but that stone only comes packaged with two other sizes. This means that the designer will have to plan how the other components are used in the overall plan.

This is usually accomplished by adding a border or an accent. As a result, overages or shortages may occur in certain patterns. The designer and/or installer of Unilock products accepts all responsibility for design and all associated costs incurred as a result of applying any of Unilock's suggested design patterns in a project. Please plan your project and review your order carefully prior to ordering.

TRANSFERABLE LIFETIME GUARANTEE

Unilock provides a Transferable Lifetime Guarantee* on the structural integrity of Unilock concrete paving stones and retaining wall units when used in residential applications. Any materials installed and maintained to our guidelines, and subject to normal wear, that prove defective, will be replaced without cost. Color matching cannot be guaranteed and replacement labor is not included. Proof of purchase is required.



Scan for full Guarantee details

*Transferable Lifetime Guarantee: Register your project within 60 days of your dated proof of purchase to ensure your Unilock Guarantee is fully transferable! Simply go online at unilock.com and follow instructions. Once processed, you will receive an original Transferable Warranty Certificate for your records.

PRODUCT HANDLING WARNING

Bundle Straps Under Tension - Use extreme caution when removing or handling straps. Always wear gloves, goggles, safety footwear, and protective clothing when removing or handling straps. Failure to do so may result in serious bodily injury or loss of sight.

Cut all concrete products only in well ventilated areas. Inhalation of dust is a serious health risk. A "NIOSH" (US) or a "CSA" (CDN) approved respirator, safety goggles, hearing protectors, and gloves must be worn at all times. Always "wet-cut" or "wet grind" concrete products to minimize dust.

Do not stack bundled concrete products higher than 2 bundles high. Contents of the bundle may be unstable and subject to topple when stacked. Always use extreme caution and appropriate equipment when transporting or storing bundled concrete products. Failure to do so may result in serious bodily injury or death. Always obey gross vehicle weight (GVW) loading limitations and regulations.

Hazard Rating: Fire 0, Health 1, Reactivity 0. See MSDS Concrete Masonry (Pavers). Contact Unilock for complete sheet or view safety information at Unilock.com.

Unilock assumes no liability or responsibility for loss or damage, resulting from the improper use or handling of our products, or from failure to follow instructions, warnings, and/or advisories on the product label, and on the MSDS sheet.

TRADEMARK & LEGAL INFORMATION

Umbriano® is a trademark of Metten Stein + Design GmbH & Co KG used under license by Unilock. Unilock Ltd. and Hengestone Holdings, Inc. are the owners or authorized users of all trademarks used in this publication unless otherwise specified.

Colors shown in this brochure should be used only as a guide. Colors should always be chosen from actual samples. Contact your local Unilock representative for color availability in your area. Not all products shown are available at all Unilock locations. Log on to www.unilock.com for availability. Measurements throughout this portfolio are nominal.

©2025 Hengestone Holdings, Inc.

Terms and Conditions of Sale

STANDARD TERMS

1. All orders are accepted subject to prevailing state or other taxes, applicable skid charges, and the cost of freight applying at the time of shipment. Confirm prices at the time of order, as they are subject to change.
2. The acceptance by the seller of an order shall constitute a binding contract of purchase and sale per the terms set out in this agreement.
3. These terms and conditions and the purchase order form the contract. There are no representations, warranties, or conditions expressed or implied affecting this contract other than as contained herein.
4. All sales are made in accordance with the seller's samples, which the purchaser has seen and approved. No guarantee of exact color shades is made. Color may vary from run to run.
5. Excessive defective material picked up or delivered to the purchaser will be replaced free of charge if a claim is made within five days. Free replacement will be the extent of the seller's warranty. Any such claim will not constitute a reason for delaying payment. All other claims must be submitted within 30 days of purchase. **Use of any delivered materials by or on behalf of the purchaser shall be deemed to constitute acceptance of the materials by the purchaser.** Unsuitable or unsatisfactory materials must be available for inspection by the seller to entitle the purchaser to any adjustment or credit.
6. No materials may be returned for credit except with the seller's written consent, whether such materials were ordered in excess of the purchaser's requirement, by mistake, or otherwise. Where the seller agrees to accept the return of goods, these goods are subject to freight charges and a restocking charge of 20% of their value. All goods must be returned in their original packaging. ACCESSORIES, SECTIONS, AND OPENED MATERIAL ARE NONRETURNABLE FOR ANY REASON.
7. Seller does not accept responsibility for delays in deliveries due to fire, flood, strikes, or any other condition or contingencies beyond its control.
8. The purchaser is responsible for the installation of the materials on the job site, and the seller has no responsibility in this regard.
9. All approved credit accounts are payable within thirty days of invoice. After 30 days, interest will be charged at 1.5%* per month (APR 19.65%*), calculated monthly on the balance owed at the beginning of the period. Suppose the purchaser defaults on payment of any portion of the amounts due on this account. In that case, the entire remaining unpaid balance shall, at the option of the seller, immediately become due and payable with collection costs incurred. If additional collection efforts become necessary, the applicant will be responsible for all costs, including but not limited to Finance Charges, Collection Costs, Attorney Fees, and/or Court Costs.
10. There is a mandatory \$25.00 SKID DEPOSIT CHARGE*. Standard skid deposits are for the following skids: SKIDPKGNY (48x38), SKID (48x36), SKIDPKG (38x48), SKIDLTD (Canadian material), SKIDPREM (Chicago premium products), and SKIDPKGCHI (Chicago shipping skids), which are refundable when returned in good condition. **A usage fee of \$2.00 will be charged.**
11. Skid deposits are non-refundable with two or more broken top boards or one main stringer board. Suppose you have skids loaded onto your vehicle or receive a delivery with skids in this condition. In that case, you must have the Unilock representative (loader or truck driver) note the quantity on the shipping document paperwork. The responsibility for the return of empty skids for credit rests with the purchaser. There will be a net usage fee for all skids accepted for return.

GENERAL TERMS

1. All prices are FOB. Brewster, NY; Chester, NY; Uxbridge, MA; or Doswell, VA. Contact Unilock for shipping schedules, rates, conditions, and fuel surcharges.
2. All COD orders must be paid for by ACH, with a copy of your check emailed to customer service before picking up your order or scheduling a delivery date.
3. Configurations may vary from time to time due to mold design changes. This includes square footage, shapes, and weights from bundle to bundle.
4. Delays incurred on delivery in excess of one hour will be billed to the purchaser at \$95* per hour or a fraction thereof.

CUSTOM ORDERS

1. Custom Orders refer to **Make-to-Order** nonstandard-inventoried items. A minimum 25% deposit of the order value will be required. A deposit of up to 100% may be required for specific products. Minimum quantities apply to custom orders. Custom orders may be subject to a [500] Sq.Ft. Over-run charge. Purchase orders will be required for custom order materials. Custom Orders will not be accepted for return.
2. All custom-produced products must be shipped within 30 days of the original requested delivery date. After 30 days, all custom-produced material will be subject to a monthly storage fee of \$20.00 per pallet. Please get in touch with your Territory Manager for more information.

LIMITED WARRANTY:

Unilock's internal testing suggests that the SkyView wind uplift system can significantly reduce the likelihood of rooftop paver failure or damage due to strong wind conditions; EXCEPT AS EXPRESSLY PROVIDED HEREIN, UNILOCK MAKES NO REPRESENTATIONS OR WARRANTIES WHATSOEVER WITH RESPECT TO THE PRODUCTS, WHETHER EXPRESS OR IMPLIED. WITHOUT LIMITING THE GENERALITY OF THE FOREGOING, UNILOCK HEREBY DISCLAIMS ALL OTHER WARRANTIES, INCLUDING THE IMPLIED WARRANTIES OF MERCHANTABILITY OR FITNESS FOR ANY PARTICULAR PURPOSE. SPECIFICALLY, UNILOCK DOES NOT REPRESENT OR WARRANT THAT ITS ROOFTOP PEDESTAL SYSTEMS OR ITS ROOFTOP TILES, SLABS, OR PAVERS WILL REMAIN IN PLACE IN ALL HIGH WIND CONDITIONS.

LIMITATION OF LIABILITY:

EXCEPT AS OTHERWISE EXPRESSLY SET FORTH HEREIN, IN NO EVENT SHALL UNILOCK BE LIABLE TO BUYER FOR ANY DIRECT, INCIDENTAL, INDIRECT, SPECIAL, PUNITIVE, EXEMPLARY, TORT OR CONSEQUENTIAL DAMAGES, INCLUDING BUT NOT LIMITED TO ANY DAMAGES FOR BUSINESS INTERRUPTION OR THE LOSS OF REVENUES, PROFITS OR SAVINGS, WHETHER OR NOT SUCH DAMAGES WERE FORESEEN, UNFORESEEN OR FORESEEABLE, EVEN IF UNILOCK HAS BEEN ADVISED OF THE POSSIBILITY OF SUCH DAMAGES. NOTWITHSTANDING THE FOREGOING, IN THE EVENT THE TERMS OF THIS SECTION, OR ANY PART THEREOF, SHALL BE HELD BY A COURT OF COMPETENT JURISDICTION TO BE INVALID OR UNENFORCEABLE, UNILOCK'S TOTAL AGGREGATE LIABILITY TO BUYER WITH RESPECT TO THE PRODUCTS SHALL NOT EXCEED THE PURCHASE PRICE OF THE PRODUCTS GIVING RISE TO THE CLAIM. NOTWITHSTANDING THE FOREGOING, THIS SECTION SHALL NOT RELIEVE UNILOCK FROM LIABILITY FOR DAMAGES THAT RESULT FROM UNILOCK'S OWN GROSS NEGLIGENCE OR WILLFUL OR TORTIOUS ACTS.

CONFIRM ALL PRICES AS THEY ARE SUBJECT TO CHANGE

Unilock New York, Inc. Updated: 01/23/2026

THE PERFECT MATCH FOR UNILOCK PAVERS

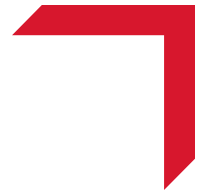

U-Cara™



SienaEdge™



Estate Wall™

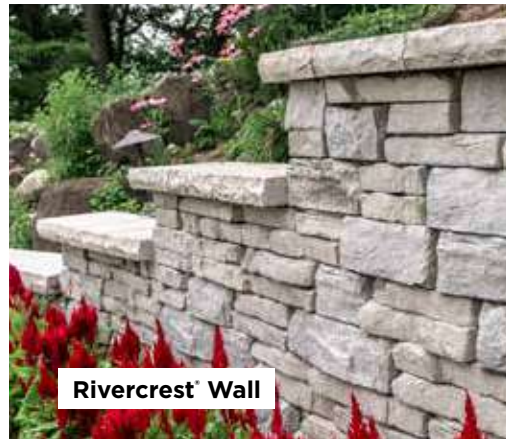

Rivercrest™ Wall



Quarry Smooth™



UNILOCK WALLS: STRENGTH MEETS STYLE

Complete your projects with wall blocks designed to coordinate seamlessly with Unilock pavers. Rich textures and premium colors create cohesive outdoor spaces, with blocks that deliver four times the industry standard for strength.

Let's **BUILD YOUR BUSINESS TOGETHER.**

**CONTACT 1-800-UNILOCK OR VISIT UNILOCK.COM TO
CONNECT WITH YOUR LOCAL TERRITORY MANAGER**

CHICAGO

(630) 892-9191

MILWAUKEE

(262) 742-3890

KANSAS

(913) 417-7985

BOSTON

(508) 278-4536

NEW YORK

(845) 278-6700

MID-ATLANTIC

(202) 798-2060

MICHIGAN

(248) 437-7037

CINCINNATI/KY/TN

(513) 202-0219

**OHIO/WESTERN PA/
WNY&CNY**

(330) 927-4000

ONTARIO

(416) 646-9000

UNILOCK®

UNILOCK.COM | 1-800-UNILOCK

